

# retro+ freak

Instructions 2018/03/27 <v2.6 English>



**Retro Freak**

CY-RF-A / CY-RF-B / CY-RF-C / CY-RF-AMZA / CY-RF-AMZB / CY-RF-BBK / CY-RF-CBK

# Index

---

<Warning> Read all the warnings prior to use	3	Button Mapping	27
Packaged Contents	4	Hotkey Configuration	28
Component Names	5	Display/Audio Output Settings	29
Connect Retro Freak	6	System Settings	30
Starting Up Retro Freak	7	In-game Menu	31
Update Retro Freak (Normal Update)	8	Storage Management	32
Update Retro Freak			
(When it includes System Update)	10		
Basic Controls [Standard Controller]	11		
Basic Controls [Other Controllers]	12		
Basic Controls [Controller Adapter]	13		
Playing a Game	14		
Using Cartridge Convertor	15		
Unable to read Cartridge	16		
Quit a game/Turn off the system	17		
Using microSD	18		
microSD directory	19		
Install a game	20		
MAIN MENU	21		
Game Lists	22		
Cheat Function	23		
Game setting	24		
Controllers	25		
Controller to Player Mapping	26		

## <Warning> Read all the warnings prior to use

---

■ This product contains delicate components; do not use or store it under extreme temperatures, give a strong impact, or abruptly pull out cables.

■ Do not use or store the console in the direct sunlight, near any heat source, or in high humidity.

■ Do not disassemble or modify the product.

■ Do not put water or any other substance in this product.

■ Do not touch USB or cartridge connectors with a finger or metallic material

■ Do not touch this product or AC adaptor with a wet hand

■ Do not use other AC adaptor other than the supplied AC adaptor

■ When the system isn't used, unplug its AC adaptor

■ Do not bend or pull AC adaptor or any cables

■ Do not use any USB devices that's not designed to use on this product. Attempting to charge or connect USB devices could become a cause of malfunction.

■ Dust or dirt on a cartridge or USB devices could be a cause of malfunction. Clean them with a dry cloth or swab before using them on this product.

■ Do not use this product with a projection or plasma TV as they are prone to leave an image burn-in on the screen.

■ Damages caused to game cartridges, microSD, and other devices by this product is not supported by this product's warranty

■ Erased or corrupted Save Data or installed games are not supported by this product's warranty

■ Do not forcefully insert or eject a game cartridge from the cartridge adaptor. Make sure a game cartridge is properly inserted into the cartridge slot.

■ Do not eject microSD or unplug AC adaptor while the system is running, shutting down, or playing a game that needs microSD. It could corrupt data or malfunctioning the system.

■ This product does not 100% guarantee that all games or devices are compatible to run on this system even though the system requirement matches to the system. Some game cartridges and accessories may not work on this system.

■ Do not use unofficial game cartridges as it could malfunction the system. This system is not compatible for unofficial game cartridges.

■ The use of this product is subject to the terms and conditions on the license with CYBER gadget Co., Ltd. If you can not agree with the terms and conditions, you cannot use this product.

# Packaged Contents

## ■ CY-RF-A / CY-RF-B / CY-RF-C



- 1 Retro Freak Main Console  
(Docked into the cartridge adapter)
- 1 Cartridge Adapter
- 1 Retro Freak Standard Controller
- 1 HDMI Cable
- 1 AC Adapter
- 1 Product Warranty
- 1 Controller Adapter (Only for CY-RF-B/C)
- 1 USB Cable for Controller Adapter  
(Only for CY-RF-B/C)
- 1 Gear Converter (Only for CY-RF-C)

## ■ CY-RF-AMZA / CY-RF-AMZB



- 1 Retro Freak Main Console  
(Docked into the cartridge adapter)
- 1 Cartridge Adapter
- 2 Retro Freak Standard Controllers
- 1 HDMI Cable
- 1 AC Adapter
- 1 Product Warranty
- 1 Controller Adapter (Only for CY-RF-AMZB)
- 1 USB Cable for Controller Adapter  
(Only for CY-RF-AMZB)

## ■ CY-RF-BBK / CY-RF-CBK



- 1 Retro Freak Main Console  
(Docked into the cartridge adapter)
- 1 Cartridge Adapter
- 1 Retro Freak Standard Controller
- 1 HDMI Cable
- 1 AC Adapter
- 1 Product Warranty
- 1 Controller Adapter
- 1 USB Cable for Controller Adapter
- 1 Gear Converter (Only for CY-RF-CBK)

Retain the box and all the contents inside the box. They will be needed for Customer Support.

# Component Names

## Cartridge Adapter

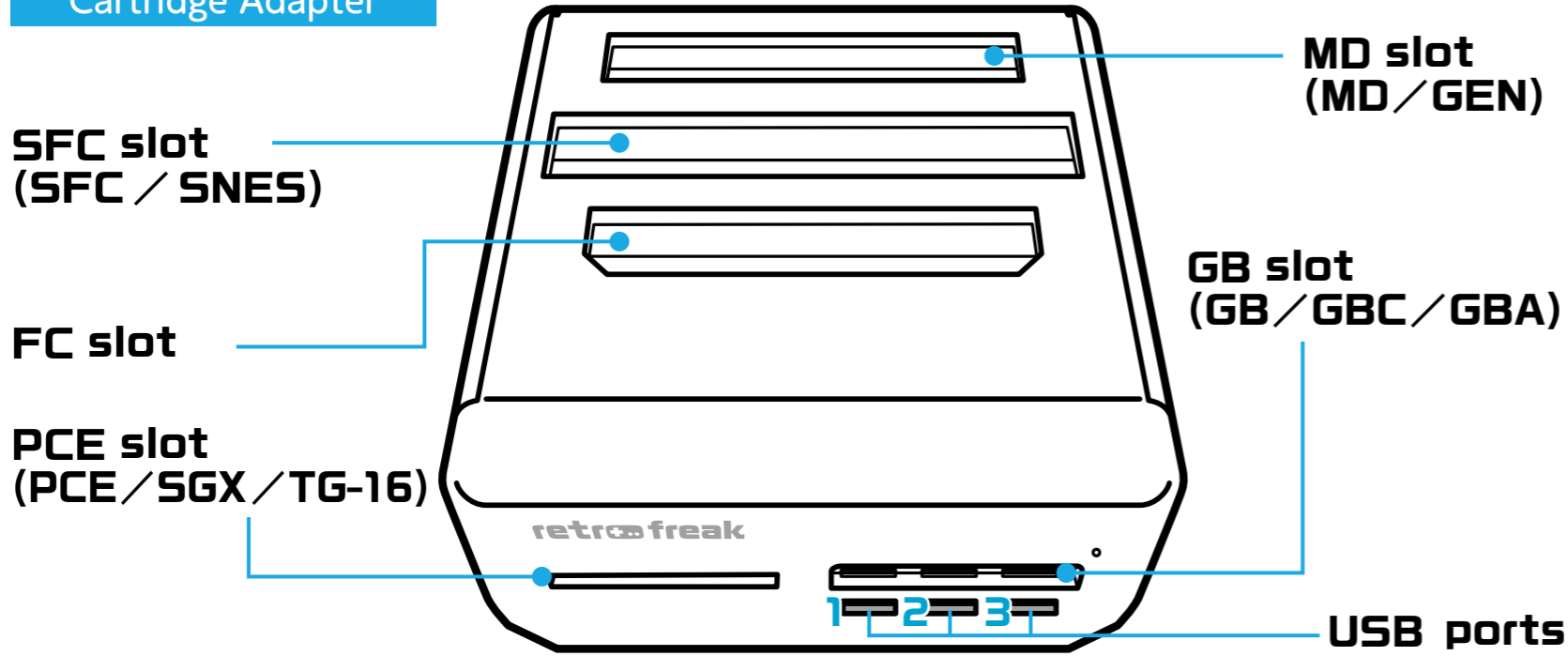

When you unbox Retro Freak, the console is docked into the cartridge adapter. To play cartridge games, leave the console in the adapter. Installed games may be played with either the console docked or undocked from the adapter

## Retro Freak Console

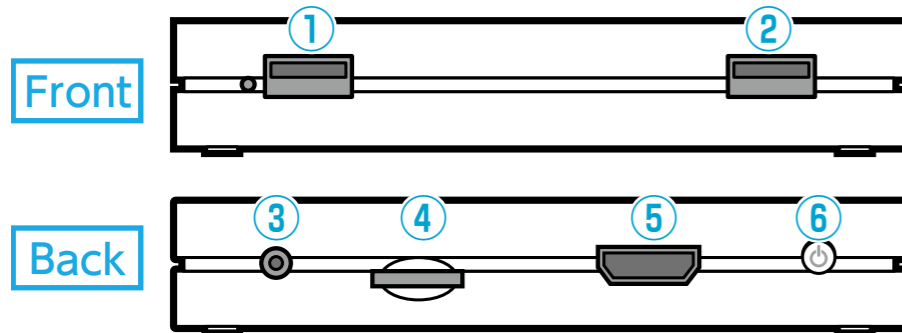

- ① USB port 1
- ② USB port 2
- ③ AC power connector
- ④ microSD slot
- \*microSD cards are sold separately
- ⑤ HDMI OUT port
- ⑥ Power button

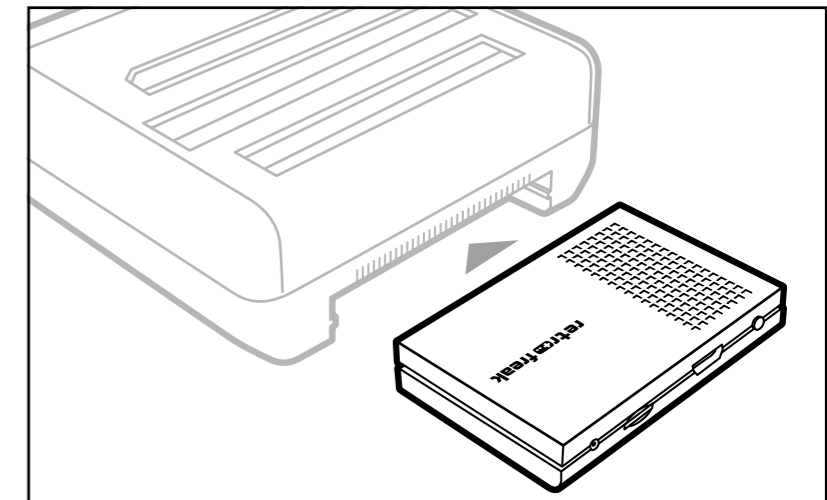

\*When unboxing your Retro Freak, the console is docked into the cartridge adapter.

# Connect Retro Freak

## Connection Overview

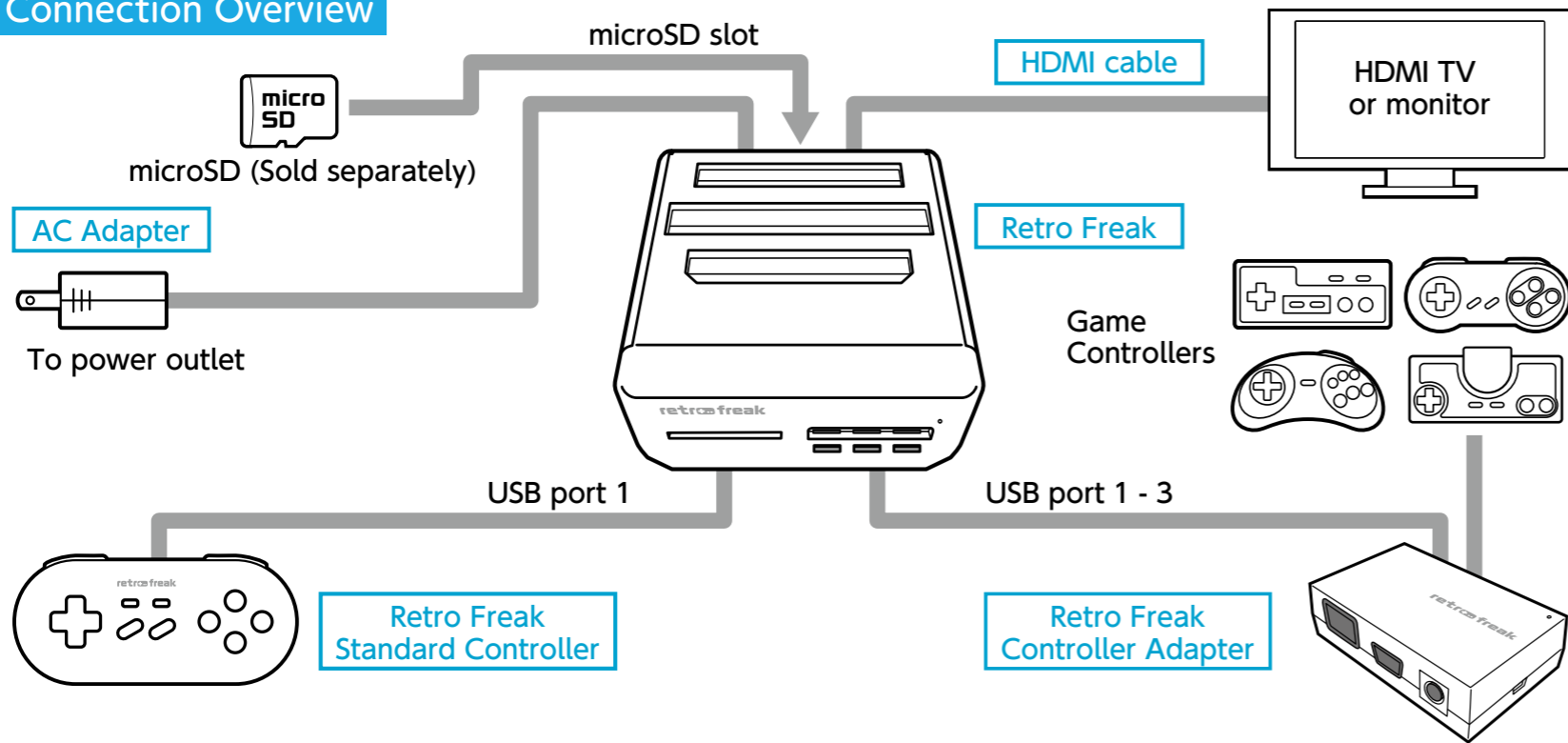

## ■ Using the Cartridge Adapter

- ① Insert the Retro Freak console into the rear of the cartridge adapter. (It's docked into the rear of the cartridge adapter when it was unboxed.)
- ② Connect the system and a TV with HDMI cable

- ③ Use a USB port in the front of cartridge adapter to connect a controller
- ④ First, connect the AC adapter to the rear of the system, and then plug it into a power outlet

## ■ Using the Retro Freak console alone

- ① Connect a TV or monitor and the system with HDMI cable
- ② Use the USB port in the front of the Retro Freak console to connect a controller
- ③ First, connect the AC adapter to the rear of the system, and then plug it into a power outlet

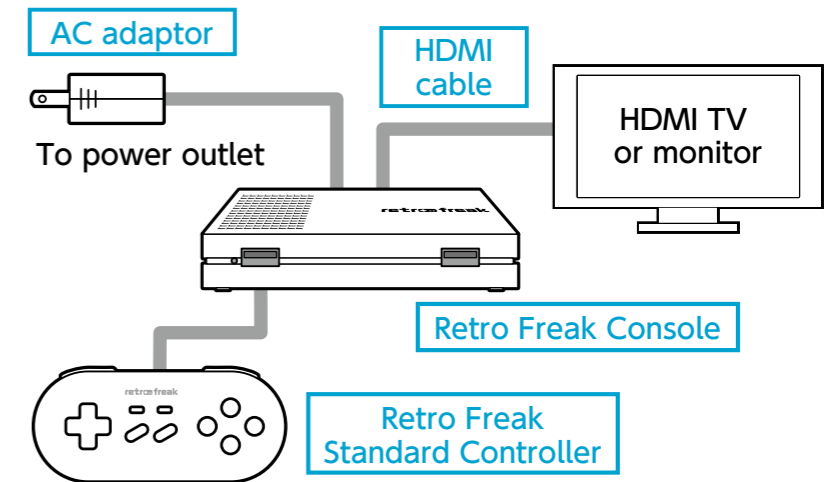

When you startup the system for the first time, connect the Retro Freak standard controller in USB port 1. After assigning controller to a player, use the registered controller.

# Starting Up Retro Freak

① Follow the direction given in the previous page to connect the console. Then, hold the power button, located in front of the console, for a second.

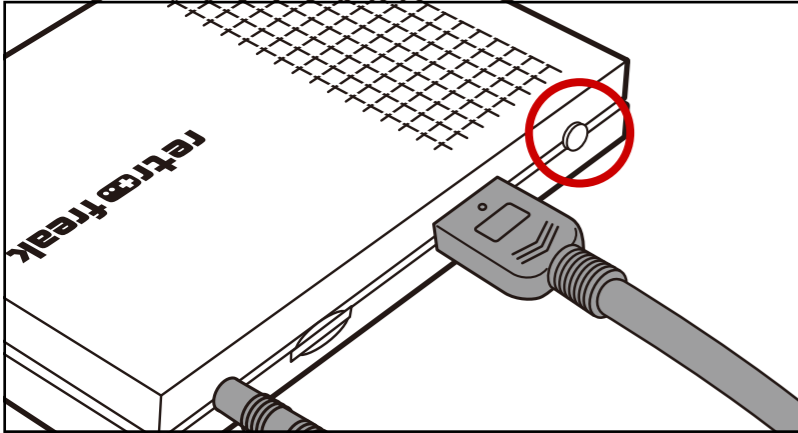

② Using the controller that's connected in USB port 1 to select language, then press [A] button. (The description from here on is when [English] was selected.)



③ Read the End-User Agreement carefully and select [Agreed] [Do not agree], then press [A] button. **You cannot use the product without agreeing on the terms**



④ Move the blue frame to fit inside your TV screen. Use Left and Right of D-pad to adjust the size, and press [A] button to confirm



⑤ Read up the detail about fresh rate on display and change the setting of TV if necessary. Press [A] button to proceed.

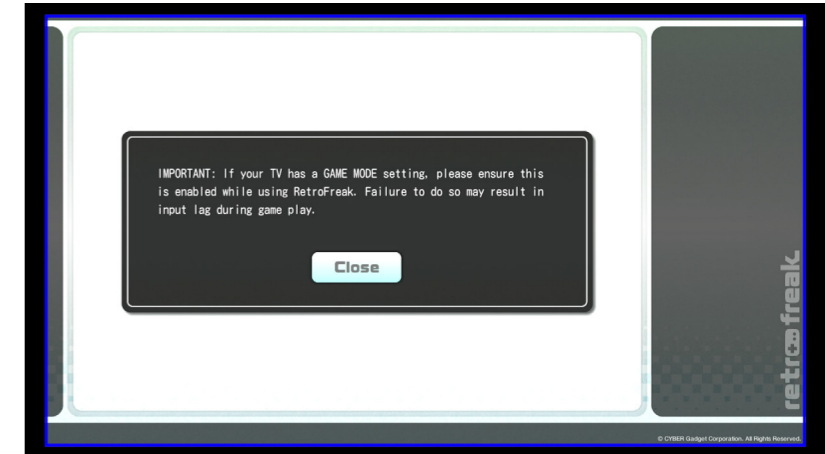

⑥ Startup will complete and it will display Main Menu

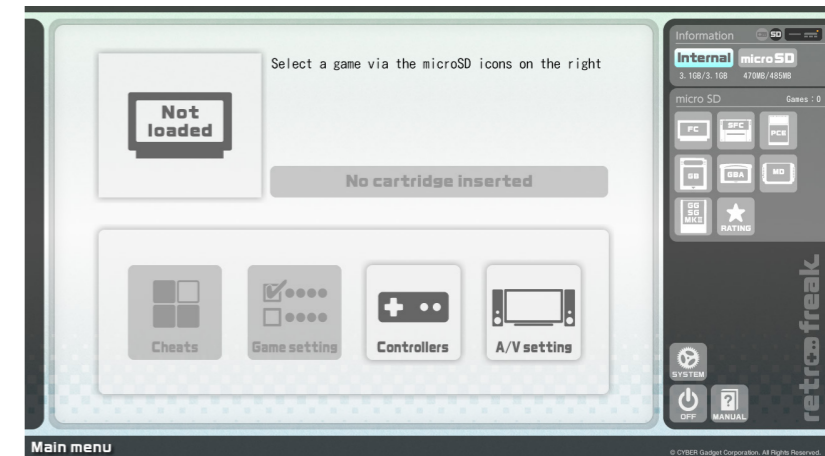

From the step ② to ⑤ only appears only for initialization

# Update Retro Freak (Normal Update)

① Insert microSD into the console, and select **[Write Firmware Update Request to microSD]** under [System Settings.] Confirm with [A] button.

\*Do the Firmware Update write-up whenever there's an update.



② Once the export is done, close the window first and then eject the microSD from the console. Insert the microSD into your computer.

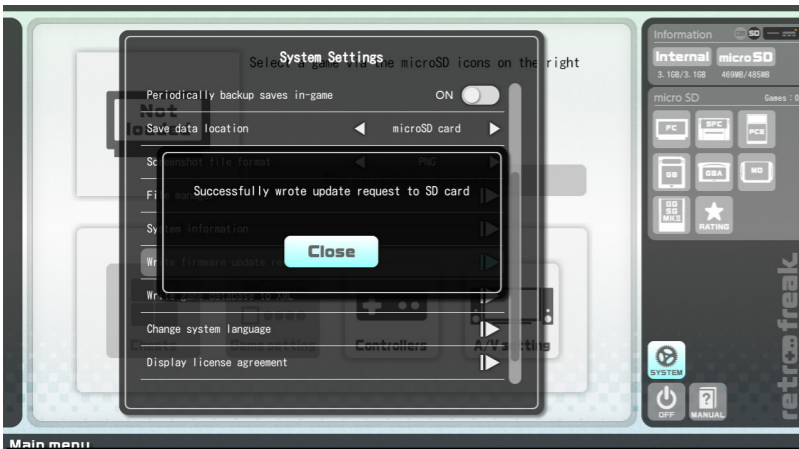

③ Connect to the Retro Freak Customer Support website, then open to the Retro Freak Update Data Download page

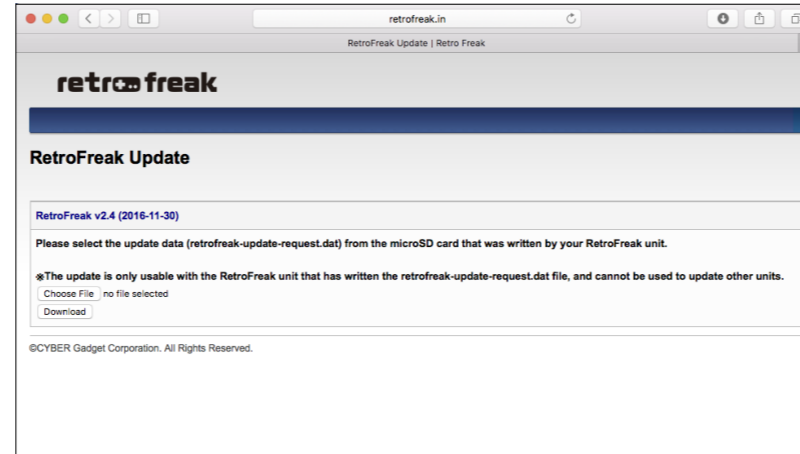

④ Click [Select a File] in the Update Data Download page, then select **[retrofreak-update-request.dat]** from the microSD directory.

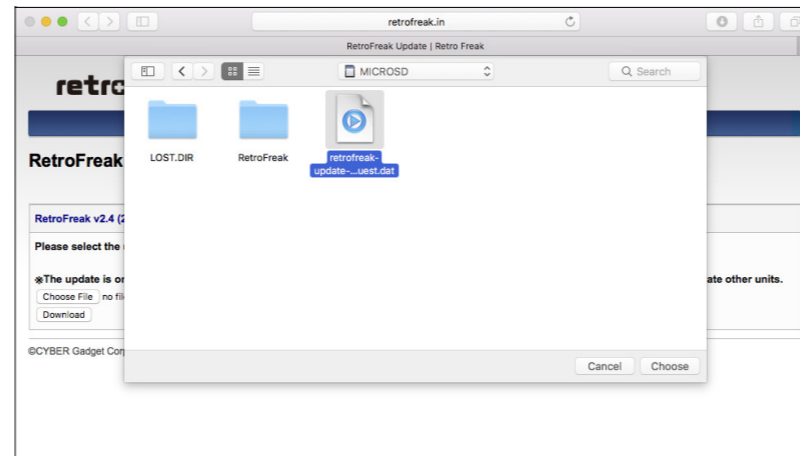

⑤ Initiate downloading **[retrofreak-update.bin]** by clicking [Download] button. Copy and place this file into the same directory as [retrofreak-update-request.dat]

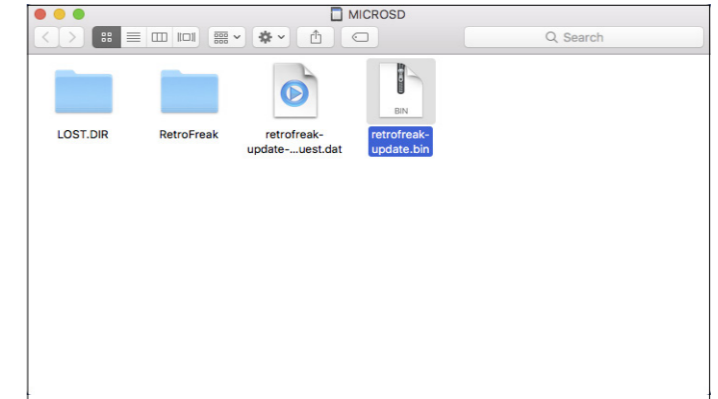

⑥ Eject microSD that contains **[retrofreak-update.bin]** and insert into the Retro Freak console while the system is on. Select [Yes] to confirm.

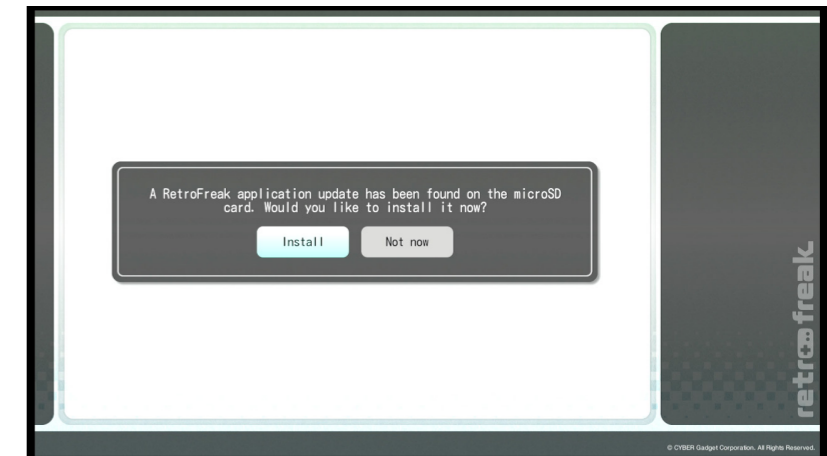

To Step ⑦ →



# Update Retro Freak (Normal Update)

⑦ Updating takes a few seconds to minutes

\*Do not turn off the system or pull out the microSD during this process.

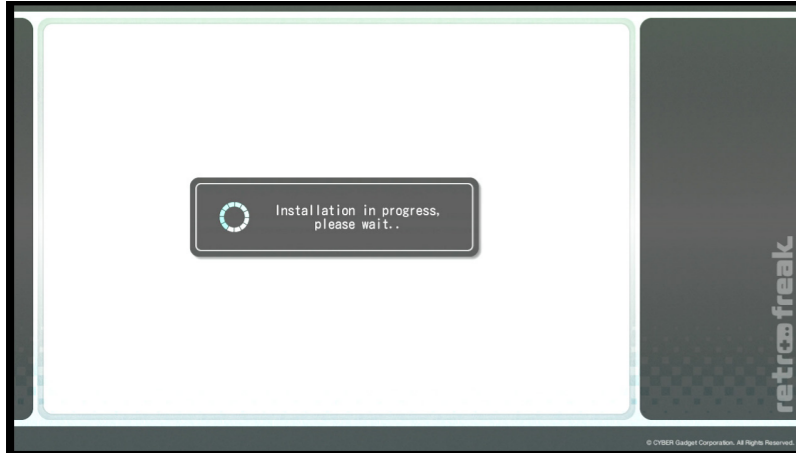

⑨ After the restart, accept the End User Agreement to complete the update



⑧ When the installation is complete, the system will automatically restart

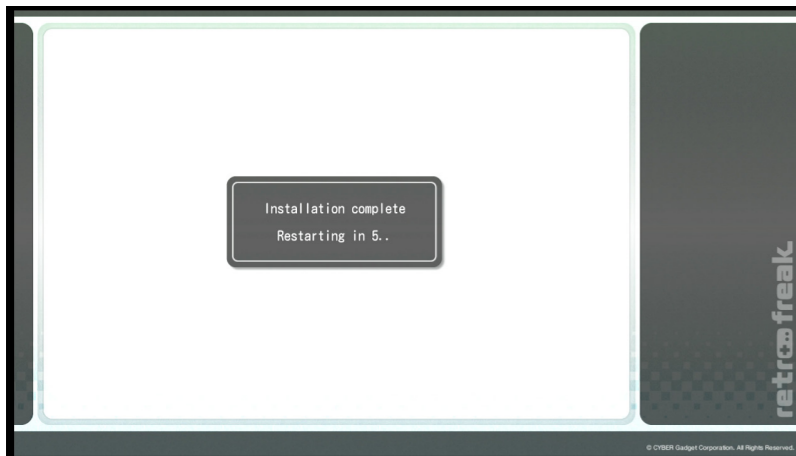

## [Updates for accessory]

If the update data contains updates for the cartridge adaptor or the controller adaptor, connect each accessory, then the update confirmation will appear upon connecting those accessories. (If the accessories were already connected to the system, their updates would appear after Step 9.) **Always accept and proceed with updates when the update notification is displayed.**

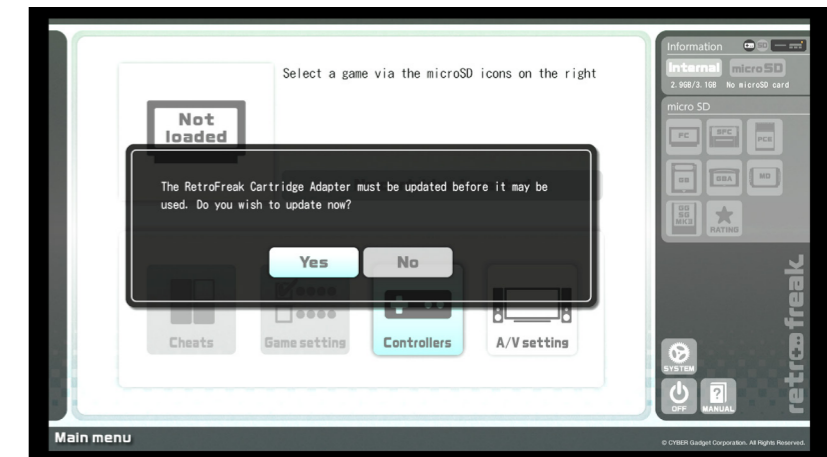

■ Retro Freak General Support webpage

<http://www.cybergadget.co.jp/support/retrofreak/>

# Update Retro Freak (When it includes System Update)

① Download an update file (zip file) from Retro Freak Customer Support webpage and unzip the folder.

■ Retro Freak General Support webpage  
<http://www.cybergadget.co.jp/support/retrofreak/>

② Copy and paste the unzipped file [retrofreak-system-update.img] to microSD directory

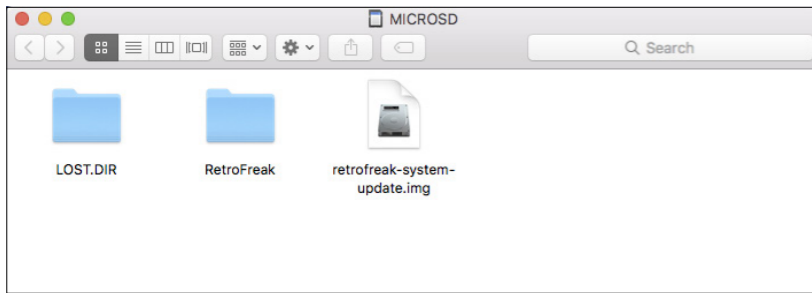

③ When inserted the microSD which contains [retrofreak-system-update.img] to Retro Freak system, a prompt to update will pop up. Press [Accept] to continue.



④ The update process will take a few seconds to minutes.

\*Do not turn off the system or pull out the microSD during this process.



⑤ When update is complete, Retro Freak will automatically restart.

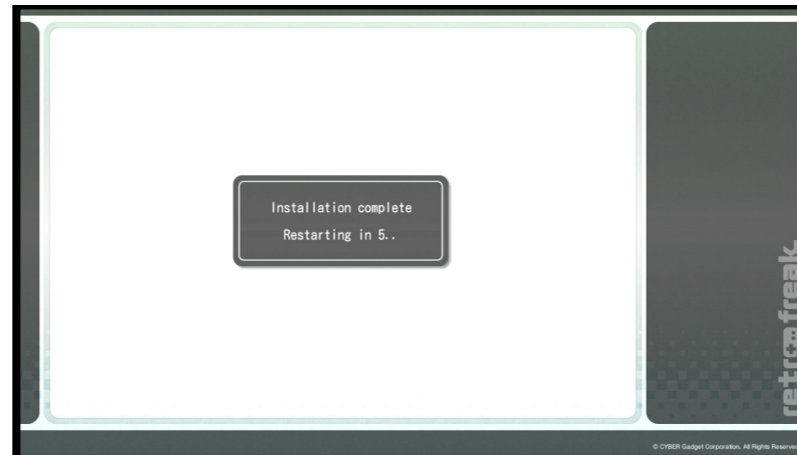

⑥ After the restart, accept the End User Agreement to complete the update

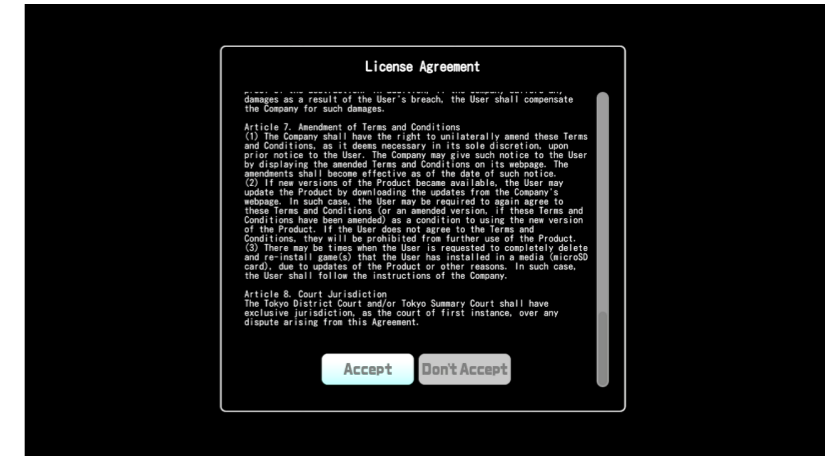

## [Updates for accessory]

If the update data contains updates for the cartridge adaptor or the controller adaptor, connect each accessory, then the update confirmation will appear upon connecting those accessories. (If the accessories were already connected to the system, their updates would appear after Step 6.) **Always accept and proceed with updates when the update notification is displayed.**

## Basic Controls [Standard Controller]

### ● Retro Freak Standard Controller

\*Connect a Retro Freak Standard controller in USB port 1 for the system's initial setup.

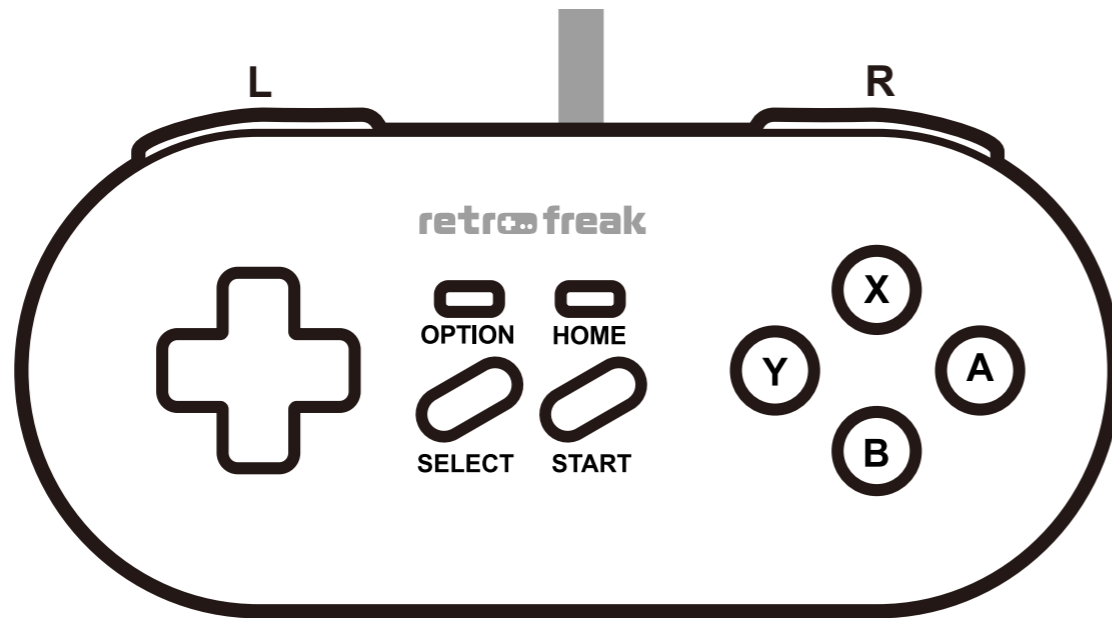

Any controller plugged into USB port 1 to 3 is available to use in Retro Freak's Main Menu. By default, USB 1 is set to Player 1, USB 2 is set to Player 2 in a game.

In-game controls are different depending on the game's system. You can view and create a button binding profile for each game system in [Button Mapping] under [Controllers].

\*A Retro Freak standard controller that's plugged into USB port 1 is always usable at the default state.

#### <MAIN MENU>

D-pad : Move cursor  
[A] button : Select/Confirm  
[B] button : Cancel/Back  
Hold [Y] + ↑ : Page Up [post v1.5]  
Hold [Y] + ↓ : Page Down [post v1.5]

#### <Game List>

Select : Sort MENU  
L/R : Change the size of the list  
OPTION : OPTION MENU

#### <In-Game>

HOME : In-game menu  
Home + [R] : Return to the Main Menu [post v1.6]  
Option : Used for following hotkeys  
Option + X : Fast forward  
Option + Y : Screenshot  
Option + L : Load state  
Option + R : Save state  
Option + SELECT : Microphone (FC only)  
Option + START : FDS Switch Disk Side (FC Only)

\*Hotkeys can be changed in [Hotkey Configuration] under [Controllers].

## Basic Controls [Other Controllers]

You can connect a USB controller or PS3/PS4 Controller to a USB port on either the Retro Freak console or cartridge adapter.

In-game controls are different depending on the game's system. You can view and create a button binding profile for each game system in [Button Mapping] under [Controllers]. Look under [Button Mappings] on this manual for more details.

### ● USB Controller

<MAIN MENU>

D-pad : Move cursor  
1 Button : Select/Confirm  
2 Button : Cancel/Back  
Other buttons : not used

\*USB controllers don't have a default in-game hotkey for [In-game menu]. Please set up the hotkey in [Hotkey Configuration] under [In-game Menu] before you start playing a game.

\*When using a USB controller with no number is assigned to its buttons, check [Button Mapping] under [Controllers]. The menu will display button numbers before assigning a new map you can refer to. This will also be helpful for a USB controller with button numbers were recognized by Retro Freak differently from actual numbering on the controller.

\*The numbers which can be assigned on buttons of a USB controller are from 1 to 13.

### ● PlayStation 3 & PlayStation 4 Controllers

To use a PS3/PS4 controller, connect it to a USB port and press [PS] button.

<MAIN MENU>

D-pad : Move cursor  
[O] Button : Select/Confirm  
[X] Button : Cancel/Back  
SELECT (SHARE) : Sort MENU(Game List)  
L1/R1 : Change the size of the list  
Other buttons : not used

<In-Game>

PS : In-game menu

\*L2/R2, L3/R3, analog stick, or touch pad on a PS3/PS4 controller cannot be used

## Basic Controls [Controller Adapter]

The following controller types can be used with Retro Freak by connecting to Controller Adapter (CY-RF-4). When using the Controller Adapter, connect to the Cartridge Adapter or main console using the supplied USB cable.

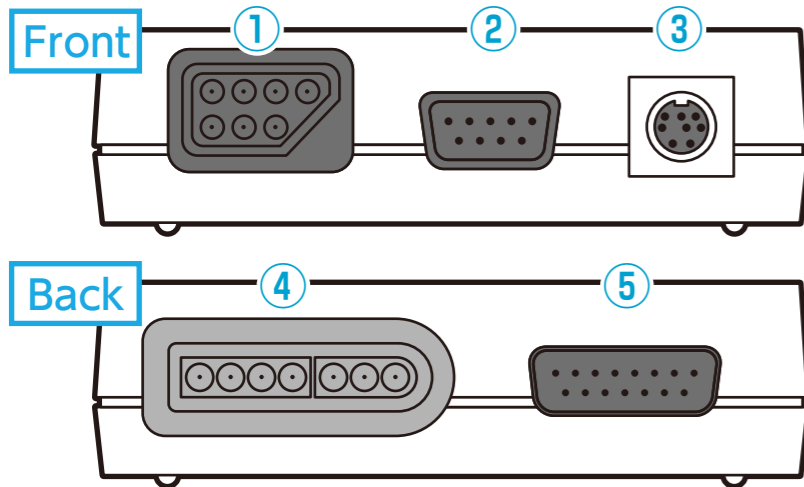

- ① NES/AV Famicom
- ② Genesis/Mega Drive
- ③ TurboDuo/PC Engine
- ④ SNES/Super Famicom
- ⑤ Famicom Expansion port

For the controllers usable with the Controller Adapter, please see following button information.

- NES/AV Famicom
- Genesis/Mega Drive
- SNES/Super Famicom
- Famicom Expansion

### <MAIN MENU>

D-pad : Move cursor  
[A] Button : Select/Confirm  
[B] Button : Cancel/Back  
SELECT : Sort MENU (Game List)  
Other buttons : not used

### <In-Game>

Start + ↓ : In-game menu

### ● TurboDuo/PC Engine

#### <MAIN MENU>

D-pad : Move cursor  
I Button : Select/Confirm  
II Button : Cancel/Back  
SELECT : Sort MENU (Game List)  
Other buttons : not used

#### <In-Game>

RUN + ↓ : In-game menu

In-game controls are depending on the console system of the game. You can view and create a button binding profile for each game system in [Button Mapping] under [Controllers].

### [Special Controllers]

A special controller, such as a puddle controller, cannot be operated in menus. Use a controller such as the Retro Freak standard controller to navigate through menus before starting a game to use an special controller.

# Playing a Game

① Insert a game cartridge in its corresponding slot on the cartridge adapter while the screen displays Main Menu.

\*Multiple cartridges cannot be connected at once.

② Wait for loading to complete, then select [Play] to start the game.

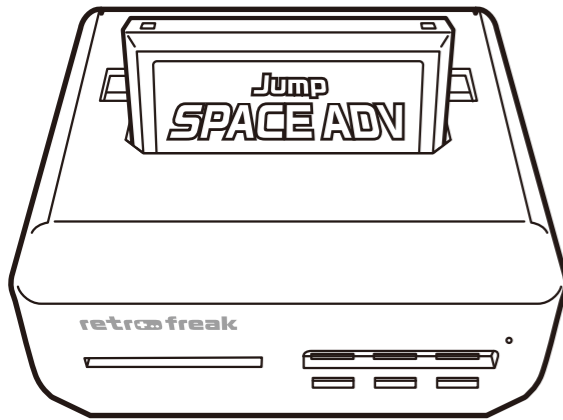
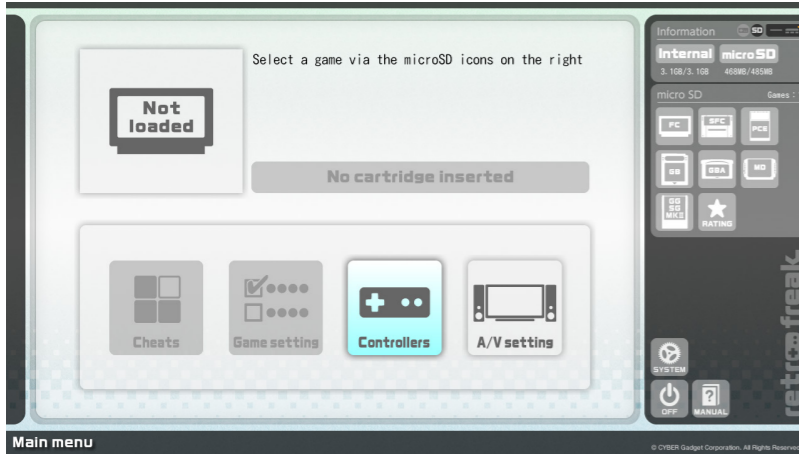

- Slots and corresponding cartridges

FC slot : Famicom, NES Cartridge Converter

SFC slot : Super Famicom, Super Nintendo Entertainment System

MD slot : Mega Drive, Sega Genesis

GB slot : Game Boy, Game Boy Color, Game Boy Advance

PCE slot : PC Engine, TurboGrafx-16, PC Engine SuperGrafx

## [Ejecting a Cartridge]

Eject a cartridge when display is on Main Menu, or the console is turned off. Ejecting during a gameplay could cause a corrupted data. To change cartridges, end the game completely **and return to Main Menu first.**

## [Saved Data]

A game played on Retro Freak saves its data on the console. When updating saved data while playing a game, the data would be stored in the system instead of in a game cartridge itself even if the cartridge was connected to the console. If you'd like to update the saved data on a cartridge, go to [Game setting] for [Write save to cartridge] and export the data from Retro Freak to the game cartridge.

# Using Cartridge Convertor

## ● Gear Convertor (CY-RF-5 / CY-RF-5BK)



By using Gear Convertor, following games are available to play on Retro Freak:

- ① Game Gear (cartridge)
- ② Sega Mark III (cartridge / Sage Card for Saga Master System / My Card Mark III)
- ③ SG-1000 (cartridge / My Card / Othello Multivision Cartridge)

\*It is not compatible to use controller with SC-3000 as well as Sega Keyboard and accessories.

① Face a label of a game cartridge front and insert it into Gear Convertor. Each slot is for following:

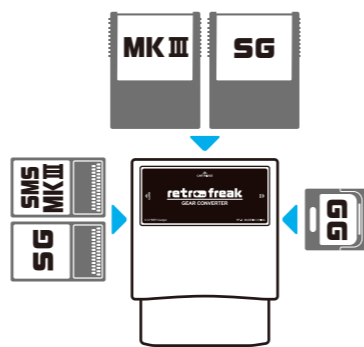

Right : GG slot

Game Gear

Top : Cartridge slot

SG-1000, Mark III,  
and Othello Multivision

Left : Card slot

SG-1000, Sega Card, and Mark  
III card

② While Main Menu is displayed, insert Gear Convertor into the **MD slot** of the cartridge adaptor.



③ When loading of a game ended, press [A] at **[Play]** and the game will start.

\*To remove cartridges, first eject Gear Convertor from the MD slot first, and then remove a game cartridge (Card).

## ● NES Cartridge Convertor (CY-RF-6)



NES Cartridge Convertor allows a user to play Nintendo Entertainment System cartridge games (NTSC/PAL) on Retro Freak.

① Face a label of cartridge front and insert it into NES Cartridge Convertor.

② While Main Menu is displayed, insert Gear Convertor into the **FC slot** of the cartridge adaptor.

③ When loading of a game ended, press [A] at **[Play]** and the game will start.

\*To remove cartridges, first eject NES Cartridge Convertor from the FC slot first, and then remove a game cartridge.

## Unable to read Cartridge

A game title will be displayed when a cartridge was recognized and successfully loaded. If warning or error was displayed, the cartridge may not be properly connected. When following warning was displayed and the game title shows [UnknownGame], select [No], eject the cartridge and re-insert it again.

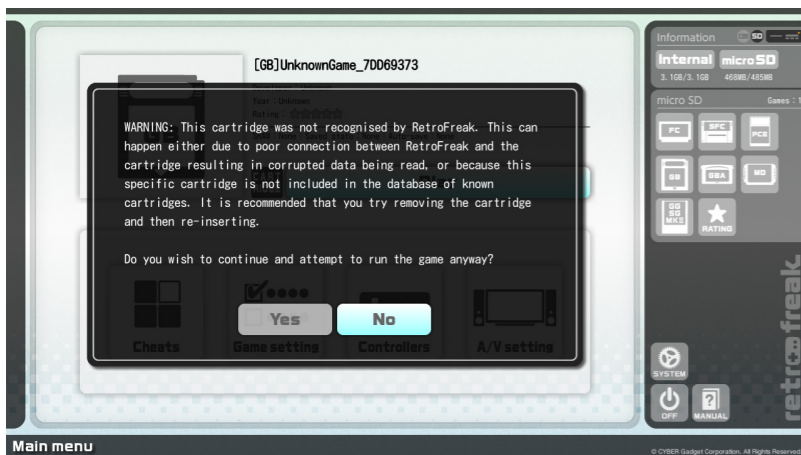

If the cartridge was not recognized even with re-insert, clean the cartridge connector with a dry cotton swab or use a specialized cleaning agent such as Nano Carbon to improve contact of metal pins.



CYBER・Nano Carbon  
CY-RFNC

If cleaning didn't help recognize the cartridge, the cartridge may not be compatible to run on this system, or unregistered version.

If a version wasn't registered, Retro Freak cannot run it with the system's current version. For more information about incompatible cartridges, visit [Retro Freak General Support webpage].

If a game version was not registered to a database, its title would not be displayed but it could be played normally.

### [Unregistered Versions]

Even a game title was same, some games have different versions depending on when they were distributed. It's been known that there are many different versions, and we'd like to cover and support as many versions as possible; however, if a cartridge hasn't been yet known, it could cause a problem with title display or system error. Currently unknown versions will be supported in the future updates as soon as we could verify the existences.

■Retro Freak General Support webpage

<http://www.cybergadget.co.jp/support/retrofreak/>



# Quit a game/Turn off the system

## ● Quit a game

Select **[BACK MAIN MENU]** under **[In-game menu]** in game  
\***[In-game menu]** is displayed by pressing the HOME button (default) of the Retro Freak standard controller.  
For other controllers, please refer to Basic Controls.

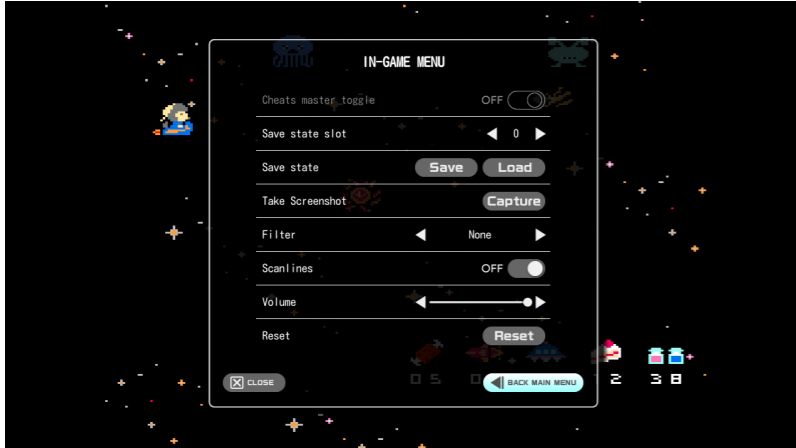

## ● Turning off the power

Method 1: Select **[OFF]** with cursor in the MAIN MENU

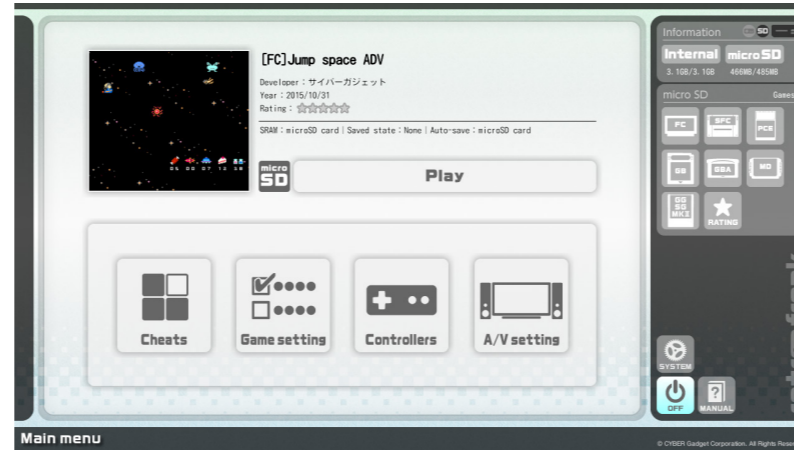

Method 2: Press and hold the power button **more than a second**

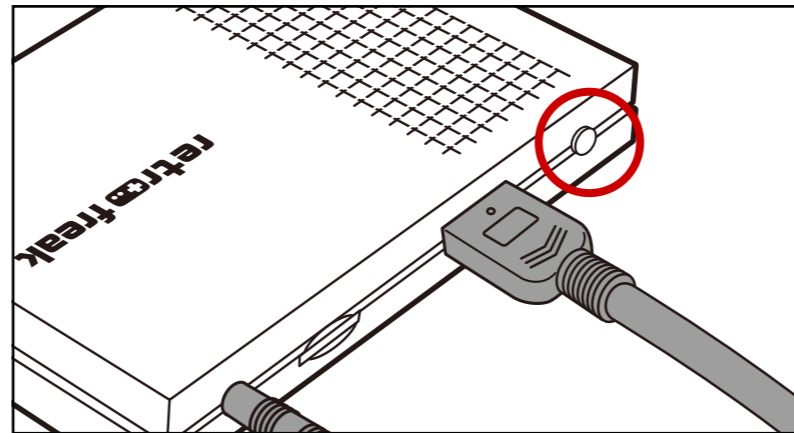

## [NOTE]

Retro Freak doesn't need to be turned off while simultaneously holding the reset button; it was conventionally done with the Famicom / NES to protect data on cartridges with Save Batteries.

## [Force Shutdown]

If Retro Freak display had frozen and unable to end a game or turn off the console normally, hold the power button for 10 seconds to force shutdown the system.

# Using microSD

Retro Freak doesn't need microSD to run an cartridge game or save a game, however using microSD will allow a user to access additional features such as installing a game, cheat functions, and other various features.

## ● Usable microSD:

You can use following FAT format (FAT16 or FAT32) microSD

- microSD (256MB to 2GB)
- microSDHC (4GB to 32GB)

## ● Features that require microSD

- System update
- Game installation
- Cheat function
- Screenshot
- Saving data to external storage

\*When saving data in a microSD, change the [Save data location] of [System setting] to [microSD].

\*Check the details for each feature in the instructions

① Insert a microSD card with its label facing up

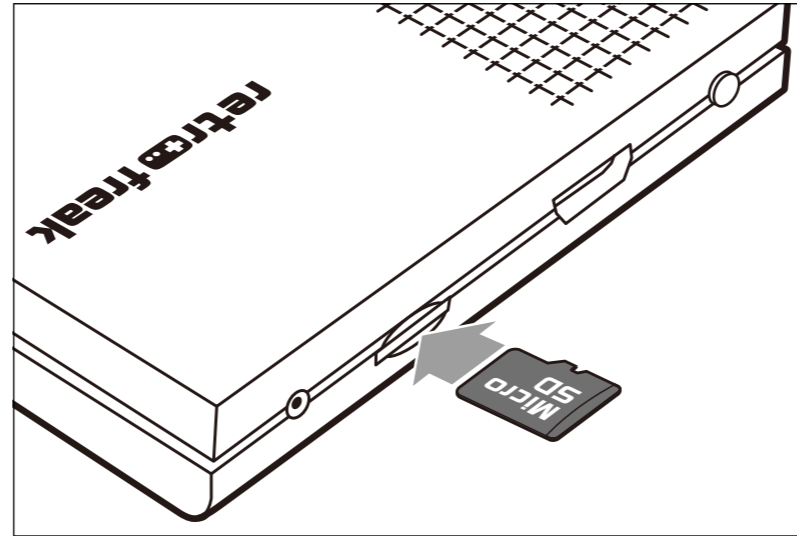

② It is ready to use when microSD icon and microSD menu are active on the screen.



microSD inserted



Without microSD

## ● Eject microSD

Push in the microSD card until it makes a clicking sound

### [IMPORTANT]

Retro Freak can read microSD that's inserted either before or after starting up the system. However, do not remove microSD or AC adapter while the system is loading, preparing to shut down, or while playing a game. Doing so can cause data to become corrupt.

# microSD directory

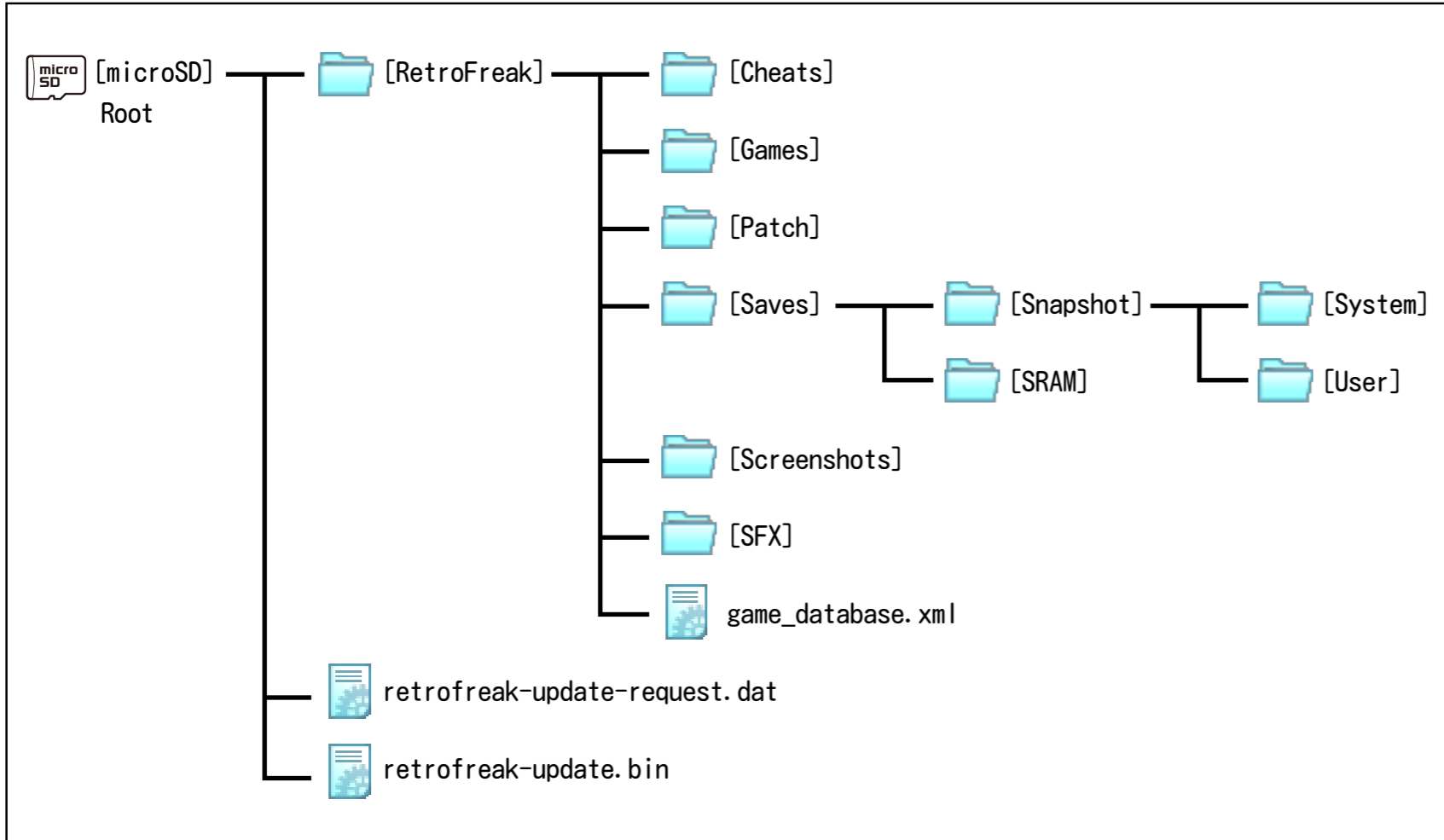

- retrofreak-update-request.dat

This is the file that would be made when selected [Write firmware update request to microSD] under [System Settings]. Select this file when you are at Update Data Download Page.

- retrofreak-update.bin

This is the Update Data file. Download this from our website and place the file at this location. This file will be automatically deleted upon completion of update.

- [Cheats]\*

Cheat codes for Cheat Function will be saved in this folder.

- [Games]

Installed games are saved in this folder.

- [Patch]\*

This folder will be referred when a patch was selected.

- [Saves]

All of saved data will be stored in this folder.

- [Snapshot]-[System]

Auto-save data will be stored in this folder.

- [Snapshot]-[User]

Saved State data will be stored in this folder.

- [SRAM]

Saved data will be stored in this folder.

- [Screenshots]

Screenshots will be stored in this folder.

- [SFX]

Obtained sound effect files are stored in this folder.

- game\_database.xml

This is a file created when [Write game database to XML] is selected under [System Settings]

\*These directories will not be auto produced. To use each function, create one in an appropriate folder.

# Install a game

① You can install a cartridge game if a microSD card is inserted in the console. After inserting a cartridge, a prompt will be displayed asking if you wish to initiate the install.

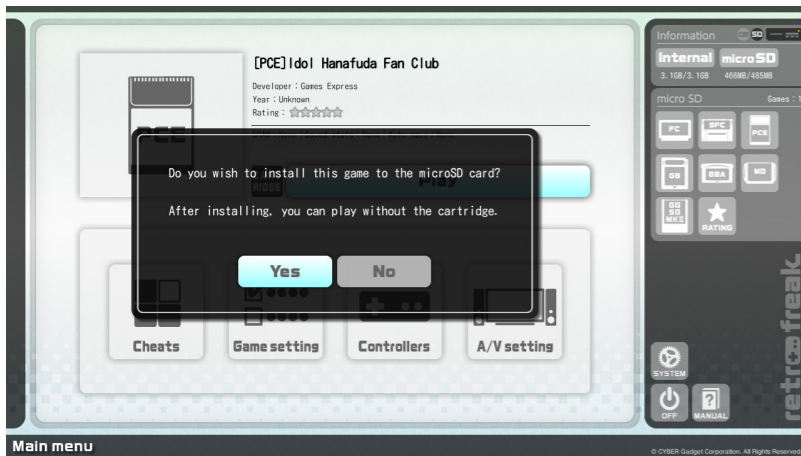

② Select [Yes] to start the installation.

Installed games are automatically categorized and displayed under following labels in microSD menu:

**FC** : Famicom / Nintendo Entertainment System

**SFC** : Super Famicom / Super Nintendo Entertainment System

**PCE** : PC Engine / TurboGrafx-16 / PC Engine SuperGrafx

**GB** : Game Boy / Game Boy Color

**GBA** : Game Boy Advance

**MD** : Mega Drive / Sega Genesis

**GG/SG/MKIII** : Game Gear / Saga Master System /  
Sega Mark III / Othello Multivision

**Rating** : All the games that are rated

## ● Playing an installed game

① Select a type of game system in microSD menu



② Choose a game from the list of games using d-pad, and press [A]

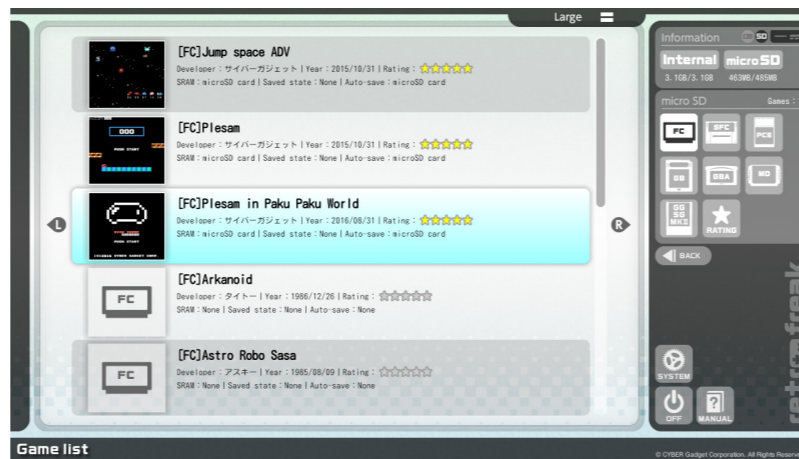

③ Wait for loading to complete, and press [A] to select [Play]

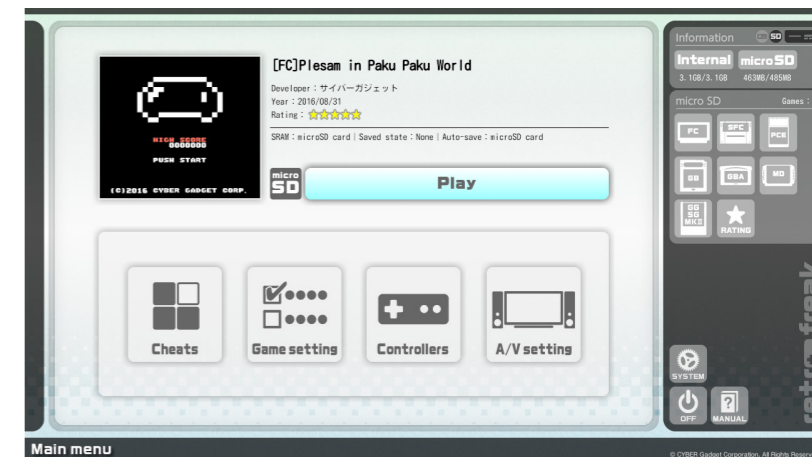

### [IMPORTANT]

Installed games are **only permitted to play on the console system you've installed the games on**. You must follow the terms of User License Agreement to install a game on microSD. Also, the use of installed games is subjected to the terms of the license agreement.

# MAIN MENU

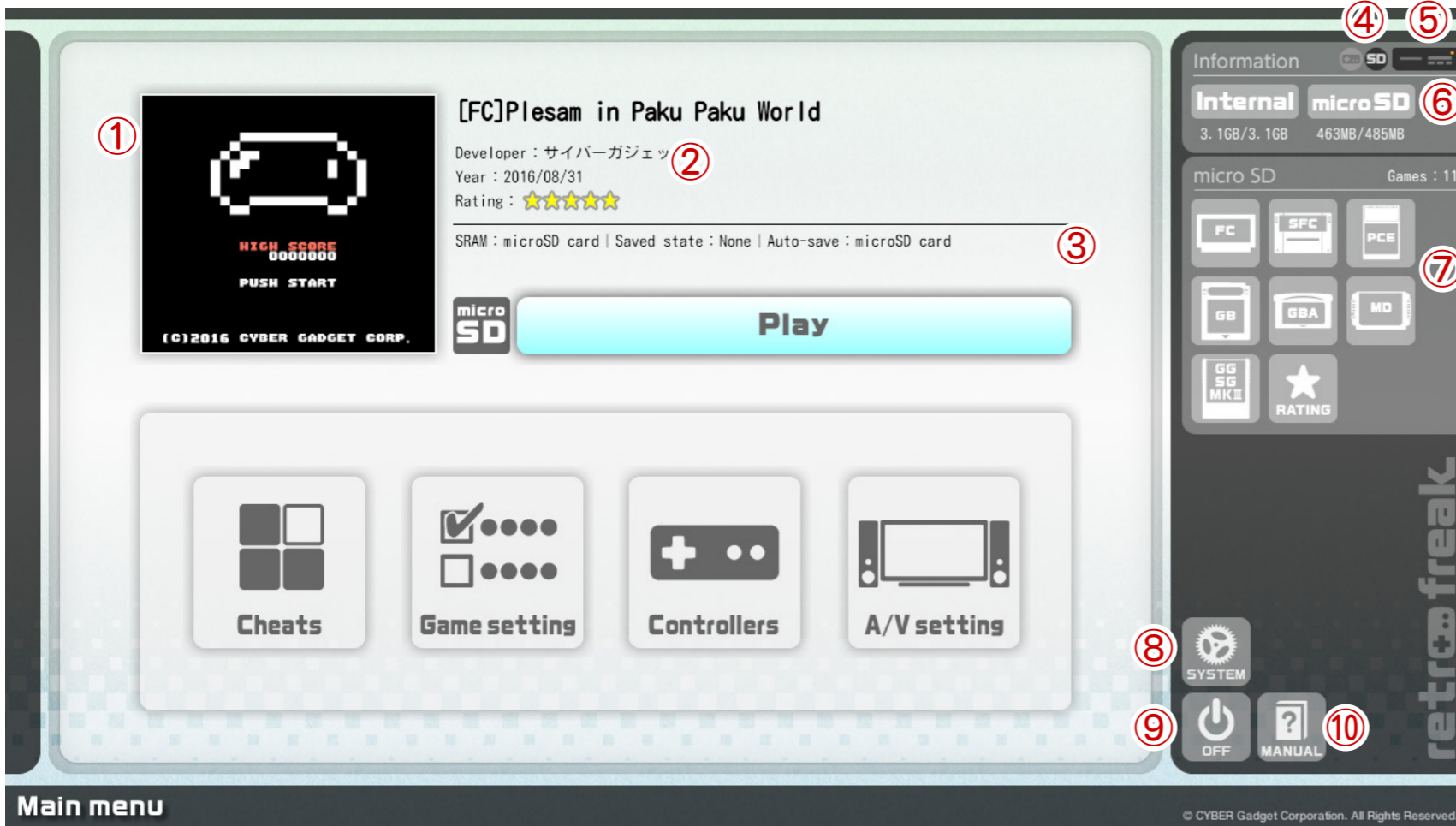

Rating : ★★★★★

Each game can be rated (1 to 5 Stars). Point cursor on [Rating] and press [A] button, use left and right of D-pad to change the rating, and then press [A] button again to finalize it. You can sort the games by rating in the game lists.

● Lock auto-screenshot [post v2.0]

Point cursor on ① and press [A] to lock screenshot. To unlock it, press [A] again and select [unlock]

🔒 : Lock    🔓 : Unlock

- ① Auto Screenshot  
Displays a screenshot of the most recent gameplay screen
- ② Game Information  
Displays distributor and release date only for games that were distributed in Japan
- ③ Game Save Status  
Displays the location, either the console or microSD, of the game's saved data
- ④ Save Data Location  
Displays the location, either the console or microSD, of the data that was saved during game play ([Save data location] of [System Settings])  
🔒 SD : Save to the system    🔓 SD : Save to the microSD
- ⑤ Connection Status of Cartridge Adapter  
🔌 : Connected    🔌 : Disconnected
- ⑥ Storage Management  
Shows the saved data manager screen
- ⑦ microSD Shortcut  
Display installed games
- ⑧ System Settings
- ⑨ Turn Off  
Turn off Retro Freak
- ⑩ User's Manual  
Shows simplified version of this manual, displayed in the language selected in [System Settings]

# Game Lists

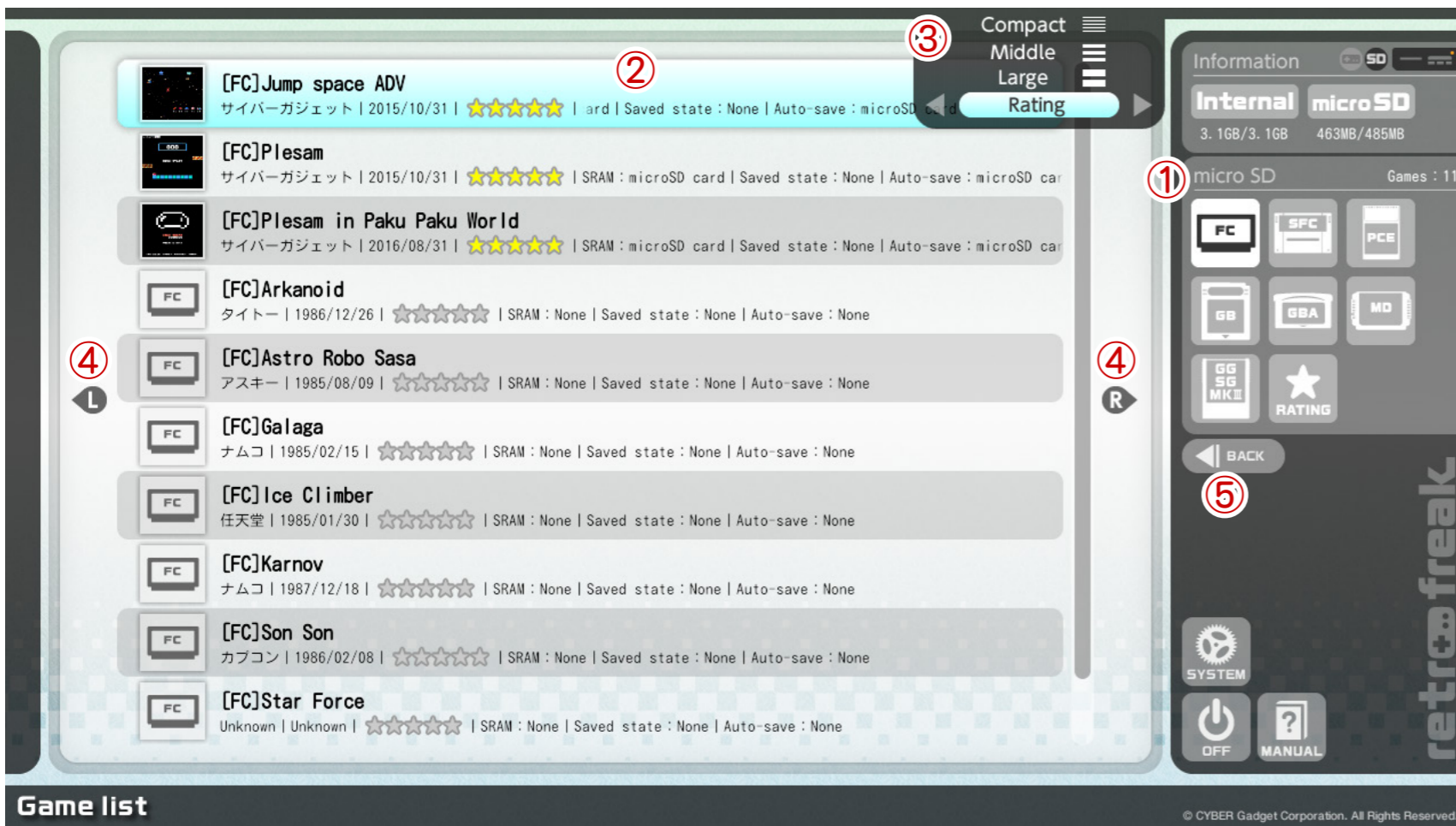

## ① microSD menu

Displays installed game titles

## ② Game Lists

Lists of installed game titles. It is displayed in alphabetical order by default.

## ③ Sort Menu

Open the sorting menu by pressing [SELECT] button in this Game Lists display. Use the cursor to navigate Up or Down using the d-pad for Font Size, press [A] to complete the selection. Point the cursor on [Alphabetical] and use Left and Right of the d-pad to change orders.

### [Sorting]

Title : sort the list by game titles in alphabetical order

Rating : sort the list from highest rating

Year : sort the list by release date of games

Developer : sort the list by producer names in alphabetical order

## ④ Change List Size

Change the size of the lists by using [L] and [R] buttons.

## ⑤ Back

Return to Main Menu

# Cheat Function

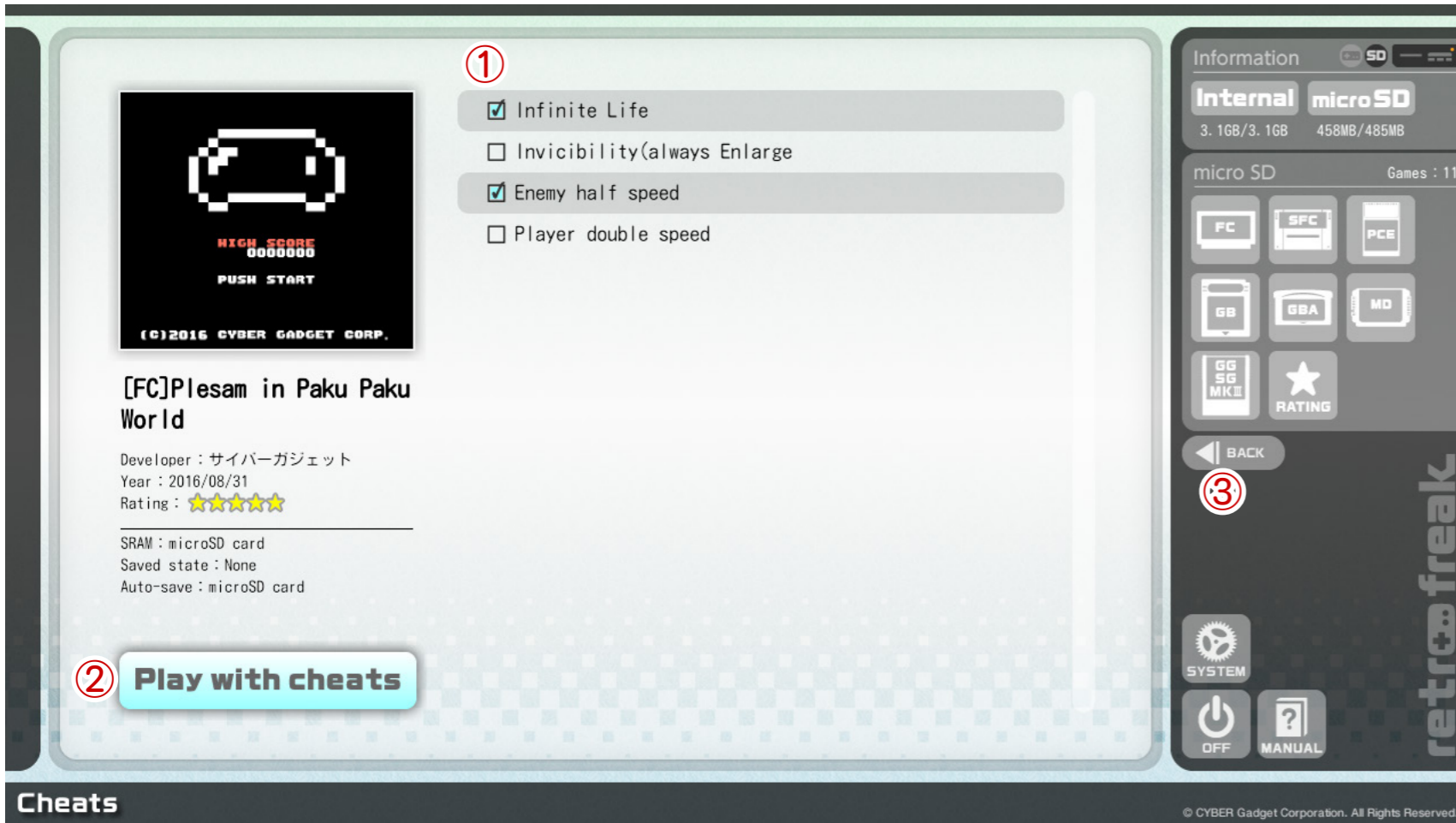

## ① List of Cheat Codes

Displays the available cheat codes. Toggle a cheat code on and off by selecting the code and pressing the [A] button.

: On (Use the Cheat Codes)

: Off (Don't use the Cheat Codes)

## ② Play with cheats

Launch a game with the Cheat Function activated. If you'd like to turn off this function during a game play, select [Off] of [Cheats master toggle] under [IN-GAME MENU], and it would void all of the Cheat Functions that were there when the game was started.

## ③ BACK

Return to the [MAIN MENU]

\*microSD and a computer are needed to use Cheat Function. For more details, check the [Retro Freak General Support webpage].

# Game setting

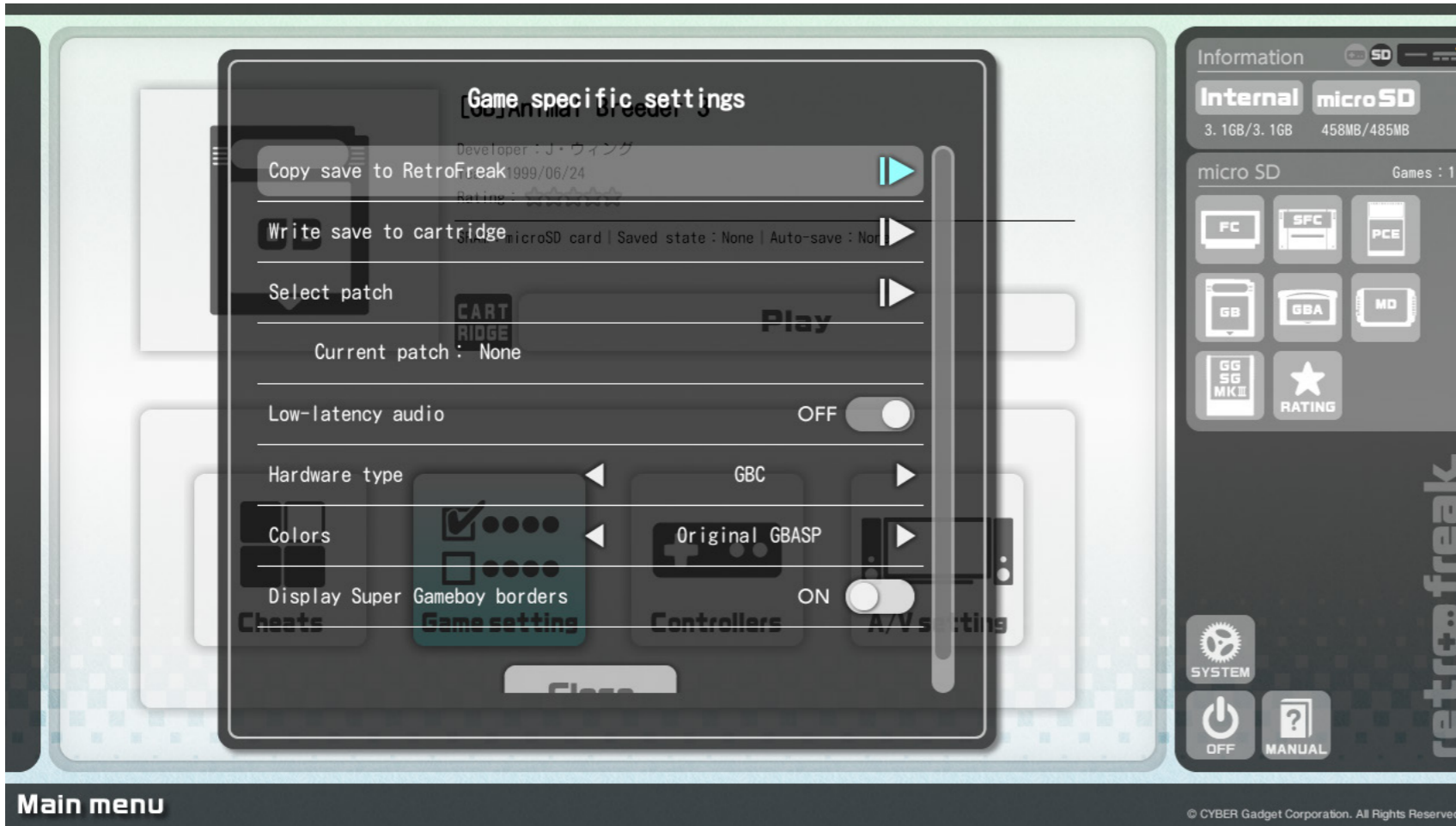

\*This menu only displays items relevant to your selected console

- Copy save to Retro Freak

Import a save data stored in the currently connected game cartridge and save it to Retro Freak, so it would be available to play the game with the save data on the Retro Freak system.

- Write save to cartridge

Export a save data stored in the system to the currently connected game cartridge. This will overwrite existing data on the cartridge.

- Select Patch

Select a patch file for emulator to apply.

- Low-latency audio [post v1.1]

Enabling this would lower audio latency to the 1/3 of normal speed, and minimize the lag between sounds and displays. Turning this OFF would lower the quality of audio and may cause the sound to break.

- Hardware Type (GB)

Change the type of hardware to imitate between GB/GBC/SGB. This is a setting for a game that changes behavior depending on hardware used.

- Colors (GB)

Change the color palette

- Display Super Gameboy border (GB)

Enable or disable the border for SGB games. When turned off, the game display would be expanded.

- Enable Vaus Controller Filter (FC)

Using a puddle controller could display flickering effect caused by noise. When turned on, it suppresses the vibrations occurring while using a paddle controller.

- Enable 6-button Controller (PCE)

Enable the Six Button Pad

- Enable FM Sound (SMS/MKIII)

Enable the FM Sound Unit



# Controllers



- **Controller to Player Mapping**  
Allow you to assign individual controllers to each game system. By default, USB port 1 is Player 1; and USB port 2 is player 2. To allow other combinations, using more than three controllers for multiplayer mode, or connect multiple controllers to the Controller Adapter as individual players, set the controller player mapping here.
- **Button Mapping**  
Allow you to check and remap button bindings and assign them to each controller and game system
- **Hotkey Configuration**  
Assign hotkeys for features available during game play
- **Fast forward speed**  
Change the speed of fast forward by a hotkey from twice to four times faster. After v1.1, it's possible to set it to slower speed from 1/2 to 1/4.
- **Turbo fire rate**  
Change the rate of a turbo button that's assigned under [Button Mapping] from 6, 15, 20, or 30 shots per second.

# Controller to Player Mapping

Default setting for controllers are recognized as Player 1 for a controller connected to USB port 1, and Player 2 for a controller connected to USB port 2(\*1).

Assign individual controllers to specific players for when you wish to assign different controller-player combination, play multiplayer games that use more than three controllers, or using Controller Adaptor for multiple controllers.

Certain, game specific controllers, such as a puddle controller and HyperShot, would be automatically recognized.



Caution!

When there are 3 or more players assigned, certain games may not function properly due to their designs (more commonly the case for Genesis/Mega Drive). If you encounter a game that does not recognize controller button presses, please try to limit the assigned players to player 1 and player 2 only.

\*1 PC Engine controller is assigned to Player 1 as its default after v1.4. If you want to use more than 2 PC Engine controllers, register at the controller-player mapping.

① Select a game system that you want to play using Left/Right buttons



② Use the controller you want to assign to the selected player, and press “A” button to assign.



\*The controller-player combinations are only effective in the system selected in Step 1. To play on the other game system, please register combination of your choice individually to each system.

Example : When you want to connect a NES controller as Player 1 and a Genesis controller as Player 2 using Controller Adapter to play a Famicom game.

- ① Select [Nes / Famicom] in the [System Playing]
- ② Use a NES controller to select [Player 1], and press “A” button
- ③ Use a Genesis controller to select [Player 2], and press “A” button

# Button Mapping

This menu is to check overviews of button mapping for each game system, and allows a user to remap each of them. Profiles can be saved for combinations of [System Playing] and [Controller used], and available to swap profiles depending on which game to play.

Default is set to each game system's official controllers; but depending on a game system, button mapping is set to [Preset] in advance in accordance with a button name used, or of a fighting game

① Select a the system and controller combination from [System Playing] and [Controller Used]. The button map that's displayed here initially is the default map for this controller.

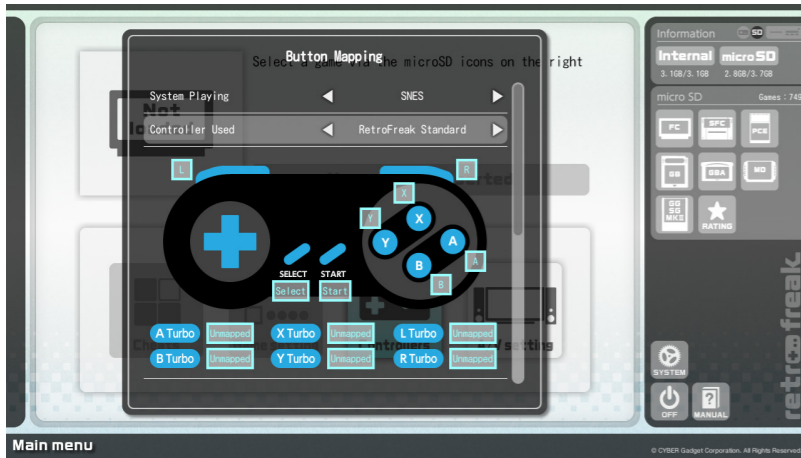

② To remap button bindings, scroll the screen to go to [Manage Profiles] and then [Add new profile]

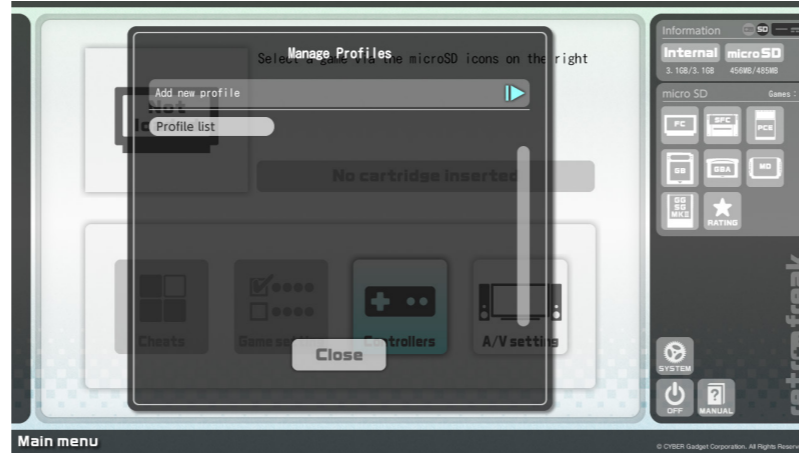

③ Name the new profile and select [enter], then press [Add]

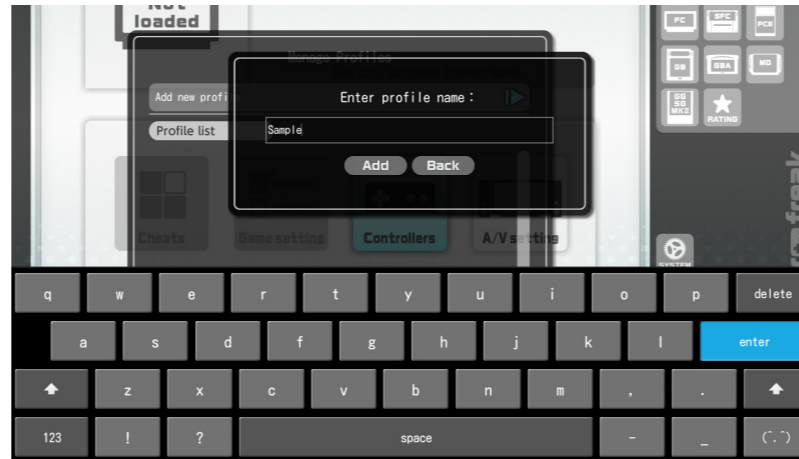

④ Select a button you want to reassign and press "A". Choose a new button to assign before the counter hits 0.

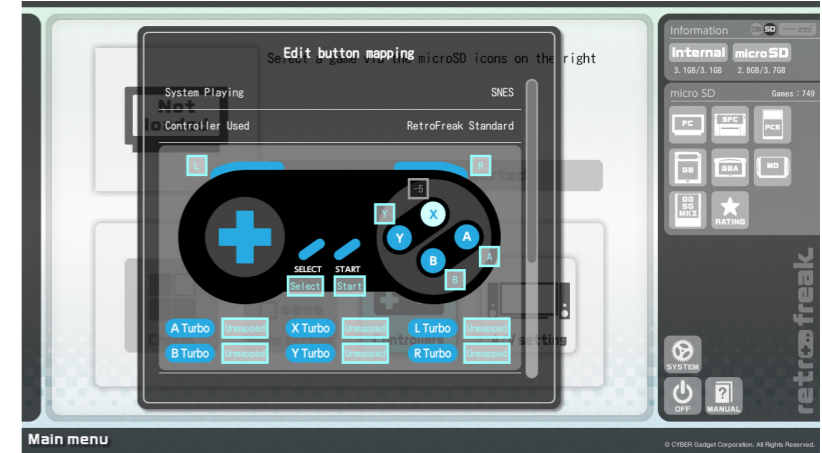

⑤ Switch to the newly saved profile under [Current Profile] section

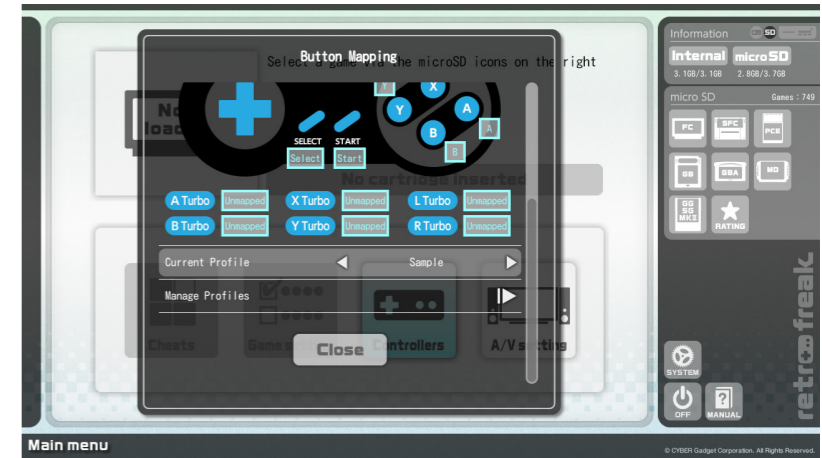

# Hotkey Configuration

The following features can be assigned as an in-game hotkey. Hotkeys can be assigned individually by a game system and controller.

- In-game menu
  - Display In-game menu
- Return to main menu [post v1.6]
  - A shortcut allows you to access to Main Menu without navigate through In-game menu.
- Fast forward
  - Overclock a game
- Save state
  - Save current game progress
- Load state
  - Load previously saved progress
- Screenshot
  - Save an image of a current display
- Cheats master toggle
  - Toggle the activated Cheat Function's on/off.
- Famicom microphone (FC Only)
  - Functions the same way as activating the microphone feature on the FC second controller
- FDS switch disk side (FC Only)
  - Switch side A/B of a FDS disk

① Select a system and controller you want to assign the hotkey to.



② Select the hotkey you want to assign, and press "A" button.



③ Select [Set] and hold a button you want to assign until the counter hits 0.



## [USB Controllers]

Since various commercially available USB controllers have different button arrangements, the [In-game menu] shortcut is not pre-assigned by default. When you use a USB controller, please setup the shortcut before start playing a game. The commercially available USB controller can assign button numbers from 1 to 10.

# Display/Audio Output Settings

- Aspect Ratio

Select the aspect ratio from [Normal], [Stretch], and [Zoom].

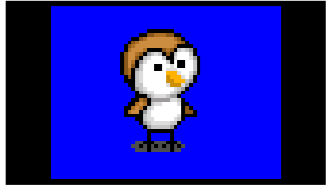

Normal



Stretch

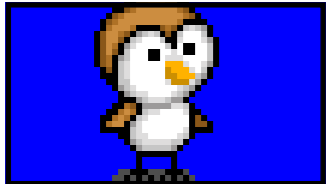

Zoom

- Image filter

Selection of video filters to enhance video display.

- Scanlines

Toggle scanlines to give the authentic feeling of CRT displays. Selecting [ON] on [Apply scanlines at main menu] would show the scanline in the main menu also. However, even if it was activated, the scanline would not appear in Screenshot.

- Display overscan

Display the overscan area without cropping it out

- Force Original Resolution

Display video in 1:1 PAR square pixel

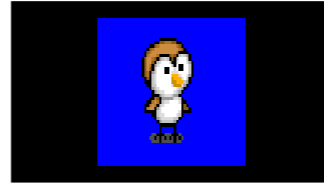

- Screen refresh rate

Change the refresh rate. [Match Game] would be sufficient for most TVs. Use this setting for a monitor that has a refresh rate cap.

- Screen Size

Change the screen size

- Force HDMI full range output

Configuration used only for monitors which require full-range RGB (such as PC monitors).

- Sound enhancement

Enhance the depth of the left and right sound channels

- Bass boost

Enhance the low frequencies

- Treble boost

Enhance the high frequencies

- GUI sound effect

Enable or disable sound effects used in the system

- Volume

Adjust the sound volume

# System Settings

---

- Console Region

Change the region of the system to [Japan], [USA], or [Europe]. When it's selected to [Auto], the system prioritize the game's region. A multi-regional game would be prioritized to set to [Japan].

PAL region games can not properly run on NTSC region [Japan / USA] standard. To play PAL region games, select [Automatic] or [Europe].

- Auto-load last state

Automatically start the game at the most recent point where you left off

- Auto-start cartridge on insertion

Automatically launch a game when a cartridge is inserted into the system

- Automatically import save on first run

Automatically import saved data stored within a cartridge when inserted for the first time

- Periodically backup saved data [post v1.3]

Periodically backup saved data while an gameplay. This function minimize data loss by unexpected power outage or system freeze up. When selected [Off] for this feature, the only saved data on the Retro Freak system would be the state when closing a game.

- Save data location

Choose save data location from [Internal storage] and [microSD card] for save data (SRAM), Save State, and auto save when microSD is connected.

- Screenshot file format

Change the file format of game's screenshot to PNG or JPEG.

- File Manager

Open the storage file manager

- System Information

Display the version of the Retro Freak system and the storage information

- Write firmware update request to microSD

Export [retrofreak-update-request.dat] file that's necessary for updating the system to the microSD

- Write game database to XML

Export installed game's database [game\_database.xml] to [RetroFreak] folder in the microSD. Database is mainly used to check CRC for adding Cheats Function.

- Change system language

Choose the system language from Japanese, English, and Chinese (Traditional).

\*When selected Chinese (Traditional) in v1.0, only End-User License Agreement will be showed in Chinese (Traditional), and Main Menu will be displayed in Japanese. This will be changed after v1.1 to show Chinese (Traditional) in Main Menu as well.

- Display license agreement

Display the terms of the end-user license agreement

# In-game Menu

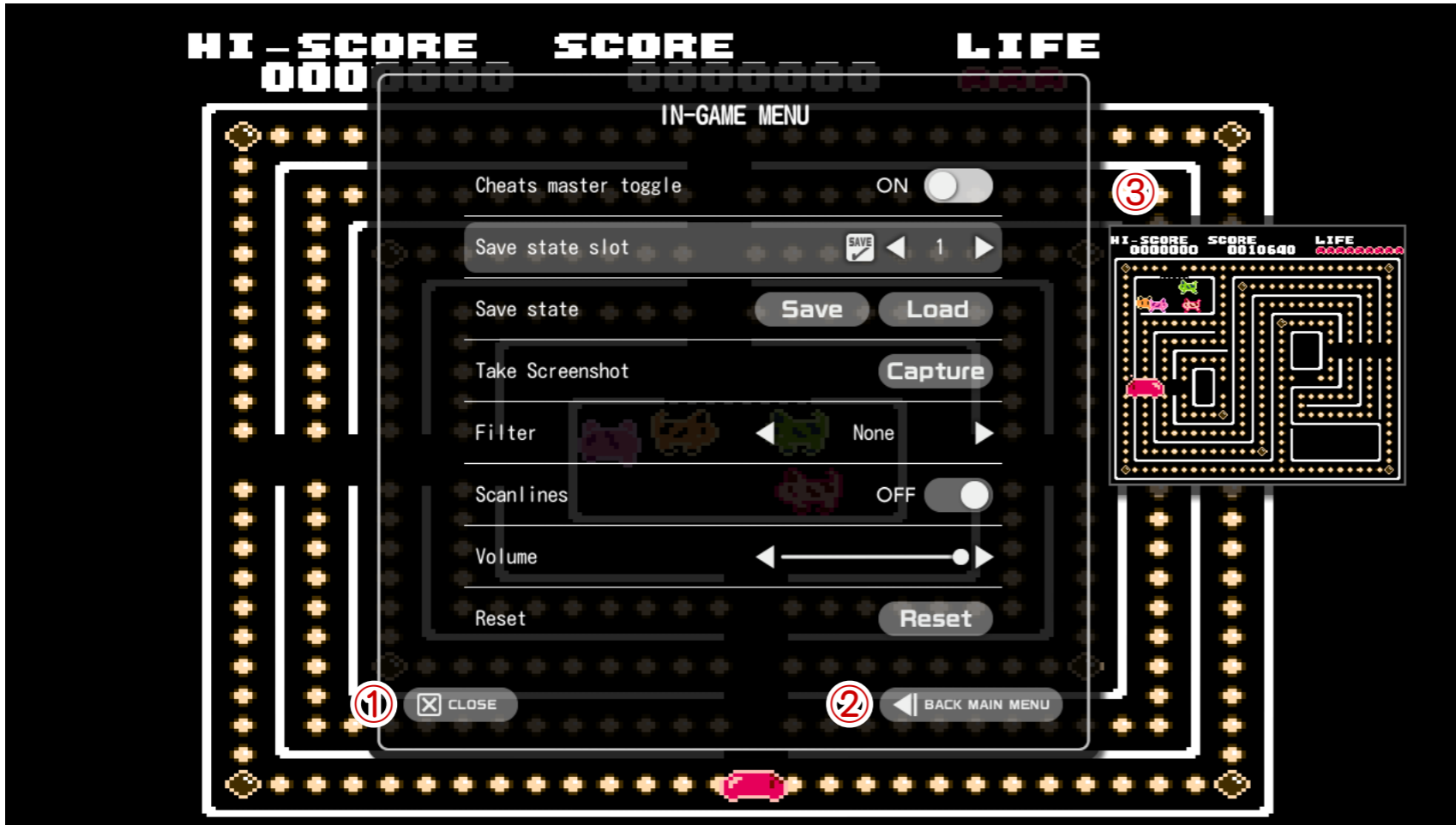

- ① CLOSE  
Close the in-game menu and return to the game
- ② BACK MAIN MENU  
End the game and return to MAIN MENU
- ③ Save State Screenshot [post v2.0]  
Displays screenshot of the moment when Save State was done. This is automatically done when Save State was commanded. Save State of pre-v1.6 will be loaded normally, but there will be no screenshot.

- Cheats master toggle  
Toggle the activated Cheat Function's on/off during game play
- Save state slot  
Change the slot used to store save states. Slots are from 0 to 99, total 100 slots. (pre-v1.6 would be from 0 to 9, total 10 slots.) You can select a slot individually from slot 0 to slot 9 and save.  
[SAVE] : [Save Data Available] would be highlighted when there's data saved in the slot.
- Save state  
[Save] : Save the currently active game to selected Save State Slot  
[Load] : Load saved data in the currently selected Save State Slot
- Take Screenshot  
Save an image of a current game display to microSD
- Filter  
Change the display filter, same as display output settings
- Scanlines  
Enable or disable scanlines
- Volume  
Change the sound volume
- Reset  
Reset the game

# Storage Management

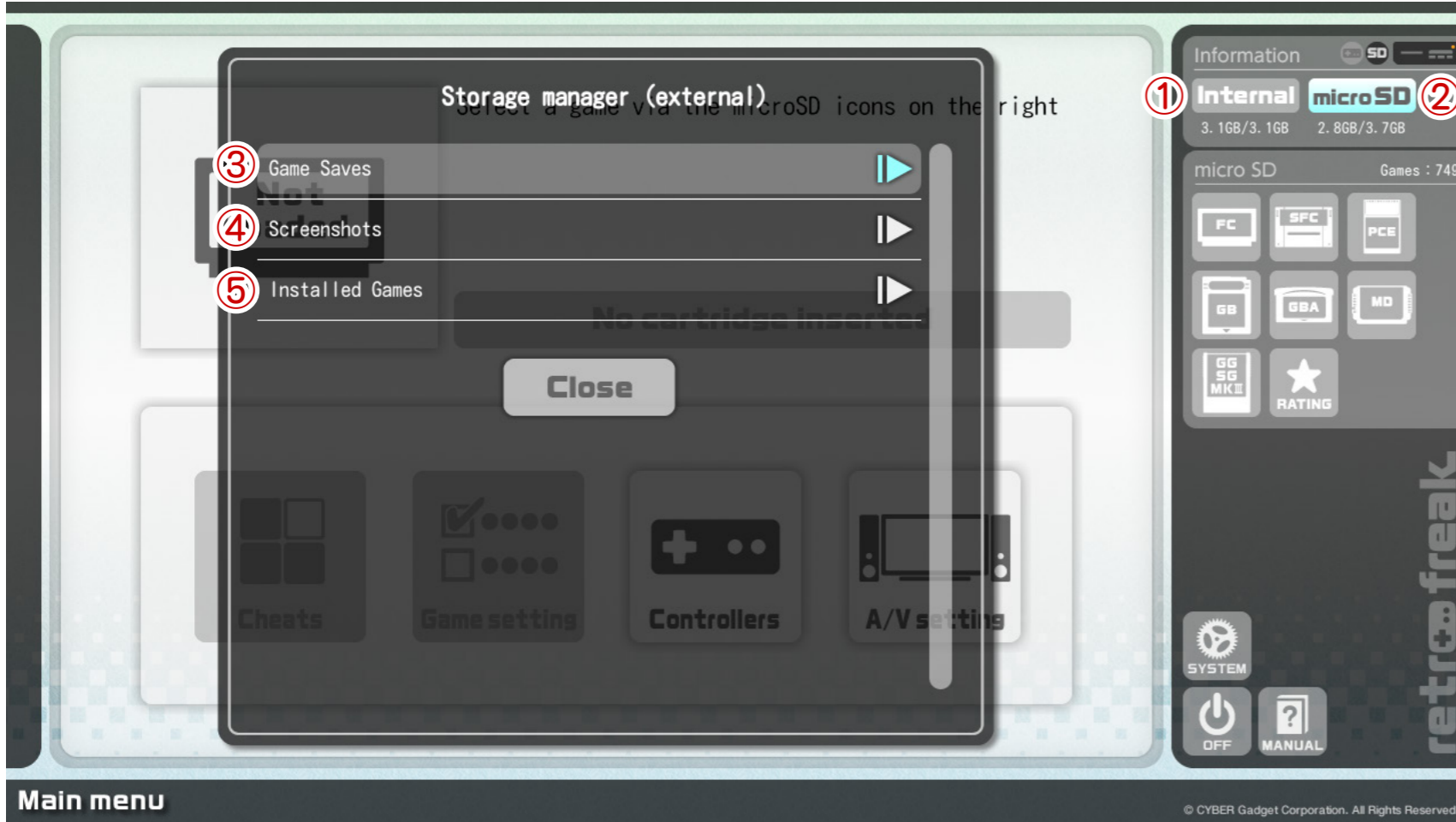

- ① Storage Manager (internal)  
Displays storage manager for saved data in the Retro Freak system
- ② Storage Manager (external)  
Displays storage manager for saved data in microSD
- ③ Game Saves  
Displays manager for saved data. By selecting a game title, it'll display all of saved data (SRAM, Snapshots, and Save State) in the storage, allow a user to copy or delete a file.
- ④ Screenshots (only from external manager)  
Displays screenshots taken during a gameplay. Allows a user to browse or delete each screenshot.
- ⑤ Game Data (only from external manager)  
Displays manager of installed game data.

\*Storage Manager is available with post v2.0



# Storage Management

## ● Manage Saved Data

① Select [Game Saves] by pressing [A] either from the console or microSD storage manager.

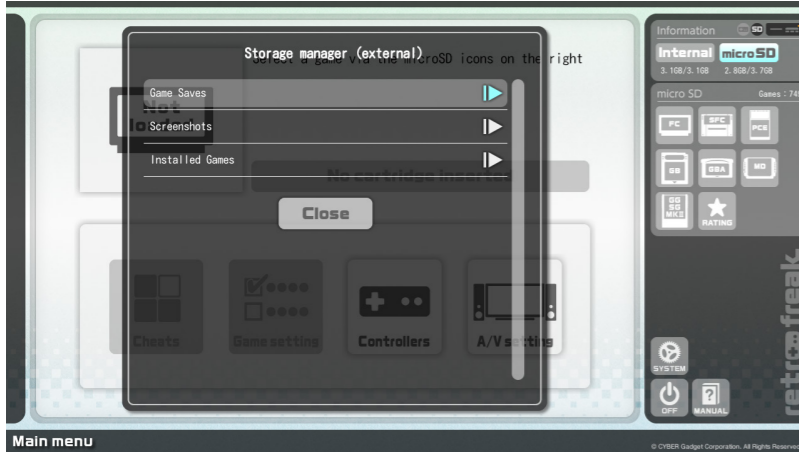

② Select a type of retro game console, and press [A]



③ Select a game title which you want to manage its Saved Data



④ Select and press [A] at [Copy] or [Delete] on chosen Saved Data



## [Copying Saved Data]

When [Copy] was selected on Saved Data management, the copied data would be saved in the other storage unit. [Copy] does not work when microSD is not connected.

Example: When copying Saved Data on the console, the copied file will be stored in microSD storage.

## [Opening a manager from Game List]

Point a cursor over a selected game title on Game List display, and press the [OPTION] button to open saved data manager or delete a saved data file.

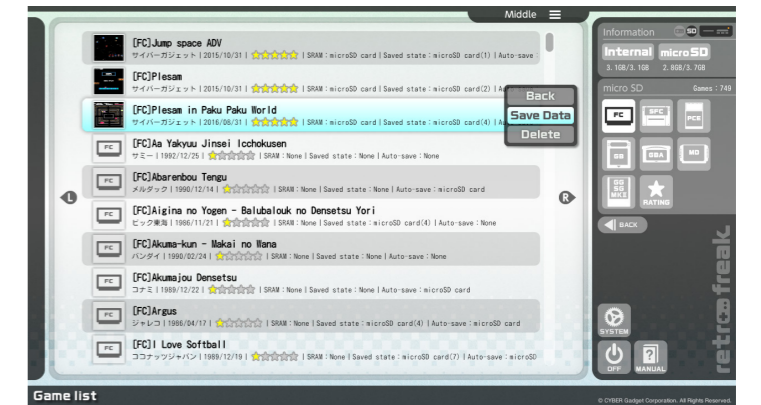

# Storage Management

## ● Manage screenshots

- ① Select [Screenshots] from microSD manager, press [A]

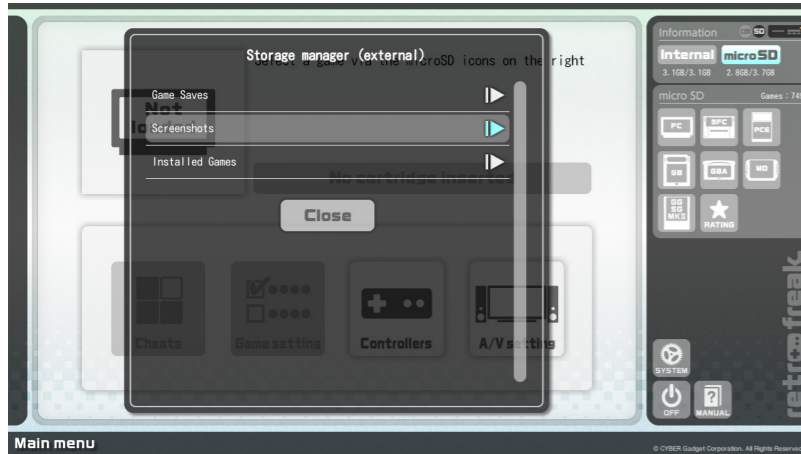

- ② Select an image and press [A] to show [Display] or [Delete]

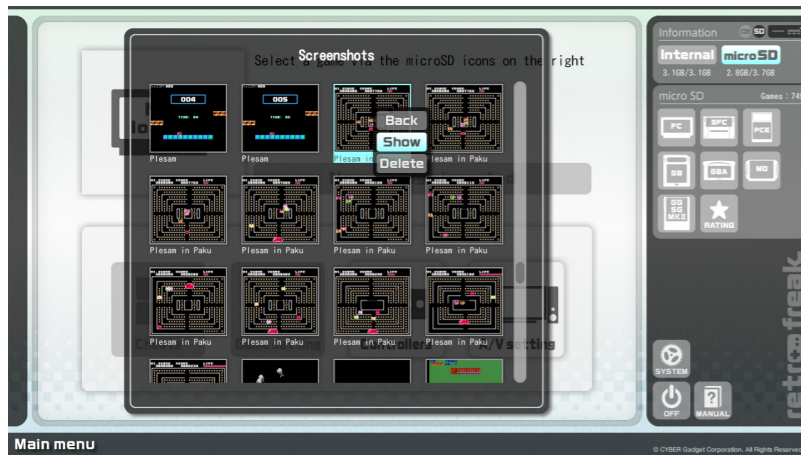

## ● Manage Game Data

- ① Select [Installed Games] from microSD manager, press [A]



- ② All the installed game titles will be displayed. Select a game data and press [A] to [Delete]

